

**SOKKIA**

**SDL 1X** Advanced  
Standard  
Digital Level

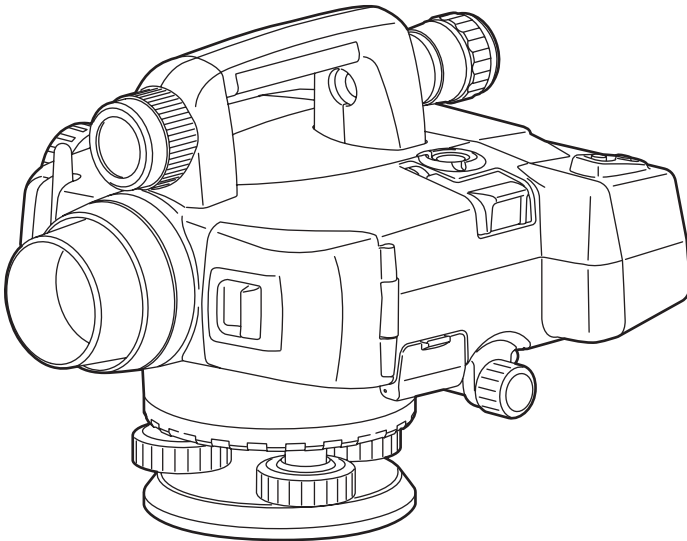

**OPERATOR'S MANUAL**



**Li-ion**

CONTAINS Li-ion BATTERY.  
MUST BE RECYCLED OR DISPOSED OF PROPERLY.

**JSIMA**

This is the mark of the Japan Surveying  
Instruments Manufacturers Association.

# SOKKIA **SDL1X** Advanced Standard Digital Level

## OPERATOR'S MANUAL

- Thank you for selecting the SDL1X Advanced/Standard.
- Please read this operator's manual carefully before using this product.
- Verify that all equipment is included.  
☞ "20. STANDARD EQUIPMENT"
- SDL1X has a function to output data to a connected host computer. Command operations from a host computer can also be performed. For details, refer to Interface Formats Explanations SDL1X Edition and ask your local dealer.
- The specifications and general appearance of the instrument are subject to change without prior notice and without obligation by Sokkia Topcon Co, Ltd. and may differ from those appearing in this manual.
- The content of this manual is subject to change without notice.
- Some of the diagrams shown in this manual may be simplified for easier understanding.

# HOW TO READ THIS MANUAL

## Symbols

---

The following conventions are used in this manual.



: Indicates precautions and important items which should be read before operations.



: Indicates the chapter title to refer to for additional information.



: Indicates supplementary explanation.



: Indicates an explanation for a particular term or operation.

**[Softkey]** etc. : Indicates softkeys on the display and window dialog buttons.

**{Key}** etc. : Indicates keys on the operation panel.

<Screen title> etc.: Indicates screen titles.

## Notes regarding manual style

---

- Except where stated, "SDL" means SDL1X Advanced and SDL1X Standard in this manual.
- Screens and illustrations appearing in this manual are of SDL1X Advanced.
- Learn basic operations in "3. PRODUCT OUTLINE" and "4. BASIC OPERATION" before you read each measurement procedure. For selecting options and inputting figures, see "4.1 Basic Key Operation".
- *Bluetooth*<sup>®</sup> is a registered trademark of Bluetooth SIG, Inc.
- All company and product names featured in this manual are trademarks or registered trademarks of each respective organization.

# CONTENTS

|      |   |    |
|------|---|----|
| 1.   | PRECAUTIONS FOR SAFE OPERATION .....  | 1  |
| 2.   | PRECAUTIONS .....   | 4  |
| 3.   | PRODUCT OUTLINE .....   | 6  |
| 3.1  | Parts of the Instrument .....   | 6  |
| 3.2  | Mode Structure .....  | 8  |
| 4.   | BASIC OPERATION .....   | 11 |
| 4.1  | Basic Key Operation .....   | 11 |
| 4.2  | Display Functions .....   | 15 |
| 5.   | USING THE BATTERY .....   | 17 |
| 5.1  | Battery Charging .....  | 17 |
| 5.2  | Installing/Removing the Battery .....   | 18 |
| 6.   | SETTING UP THE INSTRUMENT .....   | 21 |
| 6.1  | Setting Up .....  | 21 |
| 6.2  | Leveling .....  | 21 |
| 7.   | POWER ON/OFF .....  | 24 |
| 7.1  | Resolving Software Issues .....   | 25 |
| 8.   | FOCUSING and SIGHTING the STAFF .....   | 26 |
| 8.1  | Using the SDL1X Advanced.....   | 26 |
| 8.2  | Using the SDL1X Standard.....   | 28 |
| 9.   | CONNECTING TO EXTERNAL DEVICES .....  | 29 |
| 9.1  | Wireless Communication using <i>Bluetooth</i> Technology ...                          | 29 |
| 9.2  | Establishing a connection between the SDL and paired<br><i>Bluetooth</i> device ..... | 31 |
| 9.3  | Communication between the SDL and Companion Device                                    | 31 |
| 9.4  | Outputting data using <i>Bluetooth</i> communication .....                            | 32 |
| 9.5  | Connecting via Communication Cable .....  | 33 |
| 10.  | BASIC OPERATION .....   | 34 |
| 10.1 | Reading the Staff .....   | 34 |
| 10.2 | Measuring in Measure Mode .....   | 36 |
| 11.  | HEIGHT DIFFERENCE MEASUREMENT .....   | 37 |
| 11.1 | Route Setup .....   | 37 |
| 11.2 | Height Difference Measurement .....   | 41 |
| 12.  | OTHER MEASUREMENT FUNCTIONS .....   | 46 |
| 12.1 | Measuring Horizontal Angle .....  | 46 |
| 12.2 | Using the Instrument as a Standard Level .....  | 46 |

# CONTENTS



|   |    |
|---|----|
| 13. SELECTING/DELETING A JOB .....      | 47 |
| 13.1 Selecting a JOB .....              | 47 |
| 13.2 Deleting a JOB .....               | 48 |
| 14. ROUTE SETTINGS .....                | 49 |
| 14.1 Deleting a Route .....             | 49 |
| 14.2 Displaying Route Information ..... | 50 |
| 15. OUTPUTTING DATA .....               | 52 |
| 15.1 Outputting JOB Data .....          | 52 |
| 15.2 Outputting Route Data .....        | 55 |
| 16. CHANGING THE SETTINGS .....         | 58 |
| 16.1 Observation Conditions .....       | 58 |
| 16.2 Instrument Configuration .....     | 59 |
| 16.3 Communication Setup .....          | 59 |
| 16.4 Units .....                        | 60 |
| 16.5 Date and Time .....                | 60 |
| 16.6 Restoring Default Settings .....   | 61 |
| 17. WARNING AND ERROR MESSAGES .....    | 62 |
| 18. CHECKS AND ADJUSTMENTS .....        | 67 |
| 18.1 Circular Level .....               | 67 |
| 18.2 Tilt Sensor .....                  | 68 |
| 18.3 Adjusting the Reticle .....        | 71 |
| 19. POWER SUPPLY SYSTEM .....           | 75 |
| 20. STANDARD EQUIPMENT .....            | 76 |
| 20.1 SDL1X Advanced.....                | 76 |
| 20.2 SDL1X Standard.....                | 78 |
| 21. OPTIONAL ACCESSORIES .....          | 79 |
| 22. SPECIFICATIONS .....                | 80 |
| 23. REGULATIONS .....                   | 84 |



# 1. PRECAUTIONS FOR SAFE OPERATION

For the safe use of the product and prevention of injury to operators and other persons as well as prevention of property damage, items which should be observed are indicated by an exclamation point within a triangle used with WARNING and CAUTION statements in this operator's manual.

The definitions of the indications are listed below. Be sure you understand them before reading the manual's main text.





## Definition of Indication

|   |                |  |
|---|----------------|--|
|  | <b>WARNING</b> | Ignoring this indication and making an operation error could possibly result in death or serious injury to the operator. |
|  | <b>CAUTION</b> | Ignoring this indication and making an operation error could possibly result in personal injury or property damage.      |



-  This symbol indicates items for which caution (hazard warnings inclusive) is urged. Specific details are printed in or near the symbol.
-  This symbol indicates items which are prohibited. Specific details are printed in or near the symbol.
-  This symbol indicates items which must always be performed. Specific details are printed in or near the symbol.

## General

### **Warning**

-  Do not use the unit in areas exposed to high amounts of dust or ash, in areas where there is inadequate ventilation, or near combustible materials. An explosion could occur.
-  Do not perform disassembly or rebuilding. Fire, electric shock, or burns could result.
-  Never look at the sun through the telescope. Loss of eyesight could result.
-  Do not look at reflected sunlight from a prism or other reflecting object through the telescope. Loss of eyesight could result.
-  When securing the instrument in the carrying case make sure that all catches, including the side catches, are closed. Failure to do so could result in the instrument falling out while being carried, causing injury.

### **Caution**

-  Do not use the carrying case as a footstool. The case is slippery and unstable so a person could slip and fall off it.
-  Do not place the instrument in a case with a damaged catch, belt or handle. The case or instrument could be dropped and cause injury.



## 1. PRECAUTIONS FOR SAFE OPERATION

---

### Staff

---













#### **Caution**

-  Do not use under thunderous weather conditions. The staff is conductive and if struck by lightning, death or injury could result.
-  Handle with care when using near high voltage cables or transformers. The staff is conductive and contact could result in electric shock.

### Power Supply

---

#### **Warning**





-  Do not short circuit. Heat or ignition could result.
  -  Do not disassemble, rebuild, mutilate, incinerate, heat or short circuit the battery and charger. Fire, electric shock, burns or an explosion could result.
  -  Do not use voltage other than the specified power supply voltage. Fire or electrical shock could result.
  -  Do not use damaged power cords, plugs or loose outlets. Fire or electric shock could result.
  -  Do not place articles such as clothing on the battery charger while charging batteries. Sparks could be induced, leading to fire.
  -  Use only the specified battery charger to recharge batteries. Other chargers may be of different voltage rating or polarity, causing sparking which could lead to fire or burns.
  -  Do not heat or throw batteries into fire. An explosion could occur, resulting in injury.
  -  Do not use the battery, charger or AC (power) cable for any other equipment or purpose. Fire or burns caused by ignition could result.
  -  To prevent shorting of the battery in storage, apply insulating tape or equivalent to the terminals. Otherwise shorting could occur resulting in fire or burns.
  -  Do not use batteries or the battery charger if wet. Resultant shorting could lead to fire or burns.
  -  Do not connect or disconnect power supply plugs with wet hands. Electric shock could result.
- #### **Caution**
-  Do not touch liquid leaking from batteries. Harmful chemicals could cause burns or blisters.



### Tripod

---

#### **Caution**

-  When mounting the instrument to the tripod, tighten the centering screw securely. Failure to tighten the screw properly could result in the instrument falling off the tripod, causing injury.
-  Tighten securely the leg fixing screws of the tripod on which the instrument is mounted. Failure to tighten the screws could result in the tripod collapsing, causing injury.
-  Do not carry the tripod with the tripod shoes pointed at other persons. A person could be injured if struck by the tripod shoes.
-  Keep hands and feet away from the tripod shoes when fixing the tripod in the ground. A hand or foot stab wound could result.
-  Tighten the leg fixing screws securely before carrying the tripod. Failure to tighten the screws could lead to the tripod legs extending, causing injury.

### Remote Trigger (DLC1)

---





#### **Caution**

-  Do not leave batteries within reach of small children. If swallowed, consult a physician immediately.

### Bluetooth wireless technology

---

#### **Warning**

-  Do not use within the vicinity of hospitals. Malfunction of medical equipment could result.
-  Use the instrument at a distance of at least 22 cm from anyone with a cardiac pacemaker. Otherwise, the pacemaker may be adversely affected by the electromagnetic waves produced and cease to operate as normal.
-  Do not use onboard aircraft. The aircraft instrumentation may malfunction as a result.
-  Do not use within the vicinity of automatic doors, fire alarms and other devices with automatic controls as the electromagnetic waves produced may adversely affect operation resulting in an accident.

# 2. PRECAUTIONS

## Precautions concerning water and dust resistance

---

SDL conforms to IP54 specifications for waterproofing and dust resistance when the battery cover, External interface hatch, and Multi Port cap is closed.

- Make sure that moisture or dust particles do not come in contact with the terminal or connectors. Operating the instrument with moisture or dust on the terminal or connectors may cause damage to the instrument.
- Be sure to correctly attach the connector cap to protect the SDL from moisture and dust particles when the connector is not in use.
- Make sure that the inside of the carrying case and the instrument are dry before closing the case. If moisture is trapped inside the case, it may cause the instrument to rust.

## The Lithium Battery

---

The lithium battery is used to maintain the SDL Calendar & Clock function. It can back up data for approximately 5 years of normal use and storage (Temperature = 20°, humidity = about 50%), but its lifetime may be shorter depending on circumstances. When the voltage of the lithium battery has decreased, or the battery itself is depleted the date/time may not be displayed correctly and an error message "The battery for the clock function needs to be replaced." will be displayed.

For details on replacing lithium batteries contact your local dealer.

## Backing up data

---

Data should be backed up (transferred to an external device etc.) on a regular basis to prevent data loss.

## Other precautions

---

- Never place the instrument directly on the ground. Sand or dust may cause damage to the screw holes or the centering screw on the base plate.
- Protect the instrument from heavy shocks or vibration.
- Protect the instrument from rain or drizzle with an umbrella or waterproof cover.
- When the operator leaves the instrument attached to the tripod, the vinyl cover should be placed on the instrument.
- Never carry the instrument on the tripod to another site.
- Turn the power off before removing the battery.
- Remove the battery before placing the SDL in its case.
- Make sure that the instrument and the protective lining of the carrying case are dry before closing the case. The case is hermetically sealed and if moisture is trapped inside, the instrument could rust.
- Consult your local dealer before using the instrument under special conditions such as long periods of continuous use or high levels of humidity. In general, special conditions are treated as being outside the scope of the product warranty.

## Maintenance

---

- Wipe off moisture completely if the instrument gets wet during survey work.
- Always clean the instrument before returning it to the case. The lens requires special care. First, dust it off with the lens brush to remove tiny particles. Then, after providing a little condensation by breathing on the lens, wipe it with the wiping cloth.

- If the display is dirty, carefully wipe it with a soft, dry cloth. To clean other parts of the instrument or the carrying case, lightly moisten a soft cloth in a mild detergent solution. Wring out excess water until the cloth is slightly damp, then carefully wipe the surface of the unit. Do not use any organic solvents or alkaline cleaning solutions.
- Store the instrument in a dry room where the temperature remains fairly constant.
- Check the tripod for loose fit and loose screws.
- If any trouble is found on the rotatable portion, screws or optical parts (e.g. lens), contact your local dealer.
- When the instrument is not used for a long time, check it at least once every 3 months.

### "18. CHECKS AND ADJUSTMENTS"

- When removing the instrument from the carrying case, never pull it out by force. The empty carrying case should be closed to protect it from moisture.
- Check the instrument for proper adjustment periodically to maintain the instrument accuracy.

### **Exceptions from responsibility**

---

- The user of this product is expected to follow all operating instructions and make periodic checks (hardware only) of the product's performance.
- The manufacturer, or its representatives, assumes no responsibility for results of faulty or intentional usage or misuse including any direct, indirect, consequential damage, or loss of profits.
- The manufacturer, or its representatives, assumes no responsibility for consequential damage, or loss of profits due to any natural disaster, (earthquake, storms, floods etc.), fire, accident, or an act of a third party and/or usage under unusual conditions.
- The manufacturer, or its representatives, assumes no responsibility for any damage (change of data, loss of data, loss of profits, an interruption of business etc.) caused by use of the product or an unusable product.
- The manufacturer, or its representatives, assumes no responsibility for any damage, and loss of profits caused by usage different to that explained in the operator's manual.
- The manufacturer, or its representatives, assumes no responsibility for damage caused by incorrect operation, or action resulting from connecting to other products.

# 3. PRODUCT OUTLINE

## 3.1 Parts of the Instrument

### Parts of the instrument (SDL1X Advanced)

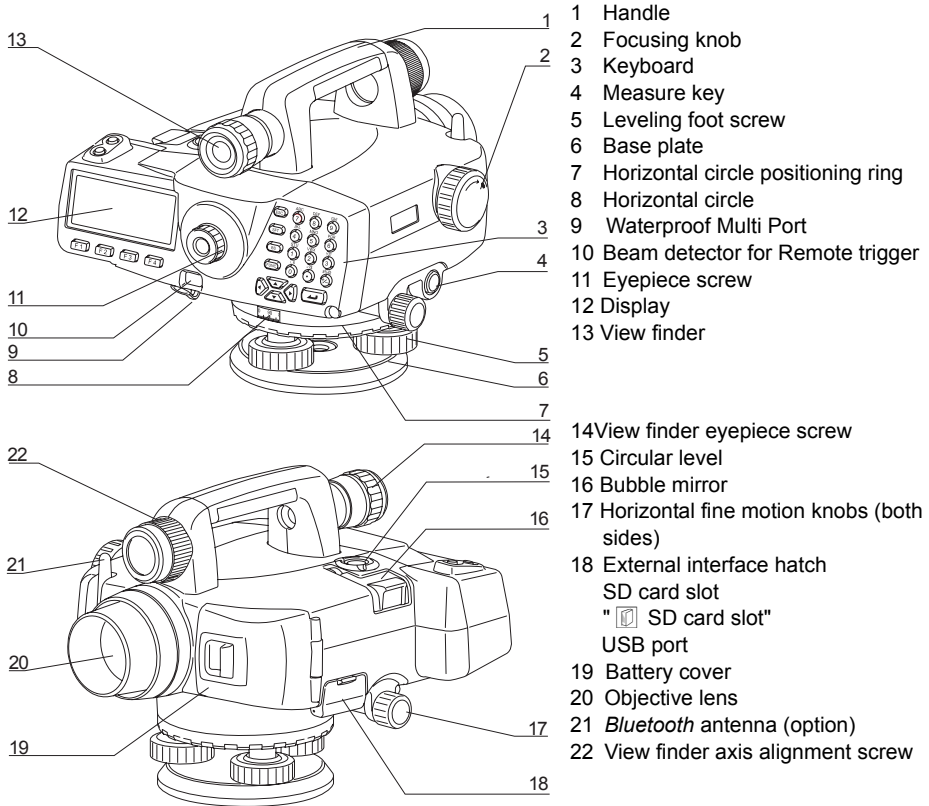

**Parts of the instrument (SDL1X Standard)**

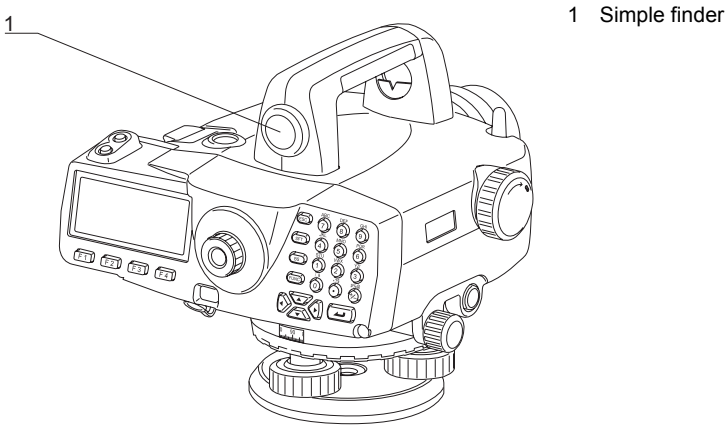

**Note**

- All other parts are identical to SDL1X Advanced.

**Functions of the instrument**



**SD card slot**

The SDL supports SD cards for data write only. The SD card slot is located in the external interface hatch.

**Inserting an SD card**

An SD card should be inserted with the contacts facing downwards.

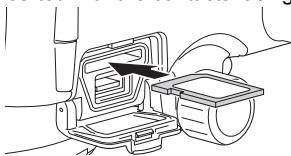

**Removing an SD card**

Push an inserted SD card further into the slot and release to eject.

## 3.2 Mode Structure

The diagram below describes the different modes of the SDL and key operations for navigating between them.

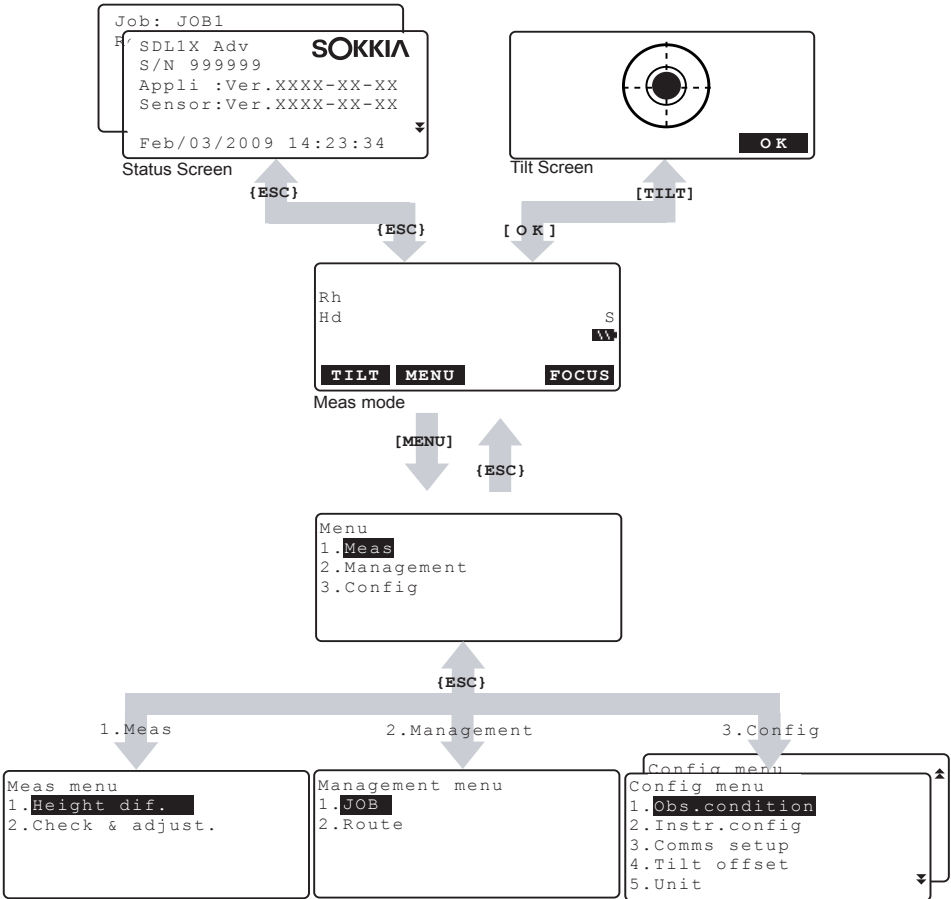

## 3.3

**Bluetooth Wireless Technology**

- *Bluetooth* communication is only possible with instruments incorporating the *Bluetooth* module.
- Use of this technology must be authorized according to telecommunications regulations of the country where the instrument is being used. Contact your local dealer in advance.
-  "23. REGULATIONS"
- Sokkia Topcon Co., Ltd. is not liable for the content of any transmission nor any content related thereto. When communicating important data, run tests beforehand to ascertain that communication is operating normally.
- Do not divulge the content of any transmission to any third party.

**Radio interference when using Bluetooth technology**

*Bluetooth* communication with the SDL uses the 2.4 GHz frequency band. This is the same band used by the devices described below.

- Industrial, scientific, and medical (ISM) equipment such as microwaves and pacemakers.
- portable premises radio equipment (license required) used in factory production lines etc.
- portable specified low-power radio equipment (license-exempt)
- IEEE802.11b/IEEE802.11g standard wireless LAN devices

The above devices use the same frequency band as *Bluetooth* communications. As a result, using the SDL within proximity to the above devices may result in interference causing communication failure or reduction of transmission speed.

Although a radio station license is not required for this instrument, bear in mind the following points when using *Bluetooth* technology for communication.

- Regarding portable premises radio equipment and portable specified low-power radio equipment:
  - Before starting transmission, check that operation will not take place within the vicinity of portable premises radio equipment or specified low-power radio equipment.
  - In the case that the instrument causes radio interference with portable premises radio equipment, terminate the connection immediately and take measures to prevent further interference (e.g. connect using an interface cable).
  - In the case that the instrument causes radio interference with portable specified low-power radio equipment, contact your local dealer.
- When using the SDL in proximity to IEEE802.11b or IEEE802.11g standard wireless LAN devices, turn off all devices not being used.
  - Interference may result, causing transmission speed to slow or even disrupting the connection completely. Turn off all devices not being used.
- Do not use the SDL in proximity to microwaves.
  - Microwave ovens can cause significant interference resulting in communication failure. Perform communication at a distance of 3m or more from microwave ovens.
- Refrain from using the SDL in proximity to televisions and radios.
  - Televisions and radios use a different frequency band to *Bluetooth* communications.

### 3. PRODUCT OUTLINE

---

However, even if the SDL is used within proximity to the above equipment with no adverse effects with regard to *Bluetooth* communication, moving a *Bluetooth* compatible device (including the SDL) closer to said equipment may result in electronic noise in sound or images, adversely affecting the performance of televisions and radios.

#### Precautions regarding transmission

---

- For best results
  - The usable range becomes shorter when obstacles block the line of sight, or devices such as PDAs or computers are used. Wood, glass and plastic will not impede communication but the usable range becomes shorter. Moreover, wood, glass and plastic containing metal frames, plates, foil and other heat shielding elements as well as coatings containing metallic powders may adversely affect *Bluetooth* communication and concrete, reinforced concrete, and metal will render it impossible.
  - Use a vinyl or plastic cover to protect the instrument from rain and moisture. Metallic materials should not be used.
  - The direction of the *Bluetooth* antenna can have adverse effects upon usable range.

- Reduced range due to atmospheric conditions

The radio waves used by the SDL may be absorbed or scattered by rain, fog, and moisture from the human body with the limit of usable range becoming lower as a result. Similarly, usable range may also shorten when performing communication in wooded areas. Moreover, as wireless devices lose signal strength when close to the ground, perform communication at as high a position as possible.



# 4. BASIC OPERATION

Learn basic key operations here before you read each measurement procedure.

## 4.1 Basic Key Operation

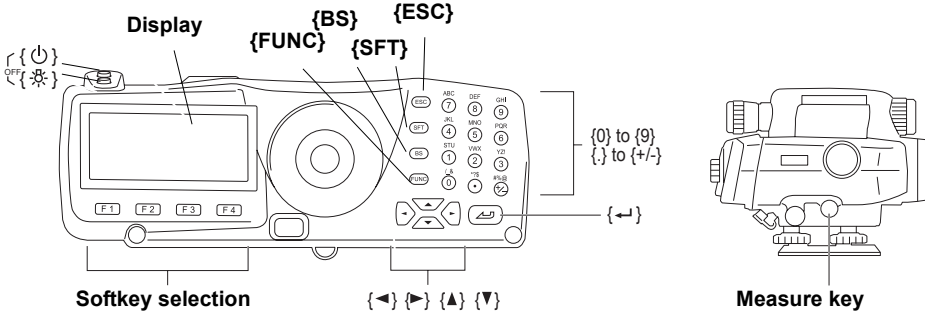

- Power ON/OFF**

|       |                      |           |
|-------|----------------------|-----------|
| { ⏻ } | (Press and hold)     | Power ON  |
| { ☀ } | while pressing { ⏻ } | Power OFF |

- Switching screen/key backlight ON/OFF**

|       |  |
|-------|--|
| { ☀ } | Switches the screen backlight/key backlight ON/OFF |
|-------|--|

- Measurement (Auto Focus)**

|             |   |
|-------------|---|
| Measure key | Automatically focuses on the staff and starts measurement. (SDL1X Advanced) |
|             | Starts measurement (SDL1X Standard)   |

- Softkey operation**

Softkeys are displayed on the bottom line of the screen.

|              |   |
|--------------|---|
| {F1} to {F4} | Select the function matching the softkeys |
| {FUNC}       | Toggle between softkey pages              |

- Inputting letters/figures**

|            |  |
|------------|--|
| {SFT}      | Switch between numeric and alphabetic (upper/lower case) characters.               |
| {0} to {9} | Input numeral or symbol printed above the key (during numeric input mode)          |
|            | Input alphabetic character in the order they are listed (in alphabetic input mode) |
| {.}        | Input a decimal point (during numeric input mode)                                  |
| {+/-}      | Input a plus or minus sign (during numeric input mode)                             |
| {←}/ {→}   | Right and left cursor/Select other option.   |
| {ESC}      | Cancel the input data.   |

## 4. BASIC OPERATION

---

|      |                                 |
|------|---------------------------------|
| {BS} | Delete a character on the left. |
| {←}  | Select/accept input word/value. |

### ● Selecting options

|        |  |
|--------|--|
| {▲}/▼} | Move the cursor/selection item up/down                           |
| {◀}/▶} | Move the cursor/selection item left/right or select other option |
| {←}    | Select/accept the option   |

### ● Other operation

|       |                           |
|-------|---------------------------|
| {ESC} | Return to previous screen |
|-------|---------------------------|

Example :Entering "Route M" in the Route ID field

1. Press **{6}** three times.  
"R" is displayed.
2. Press **{5}** three times.  
"O" is displayed.
3. Press **{1}** three times.  
"U" is displayed.
4. Press **▶}** once.
5. Press **{1}** twice.  
"T" is displayed.
6. Press **{8}** twice.  
"E" is displayed.
7. Press **▶}** twice.  
Input a blank space.
8. Press **{5}** once.  
"M" is displayed. Press **{←}** to complete inputting.

Route id  
: ROUTE M A  
Memo  
:  
:  
OK

## ►Key operation for Remote trigger (DLC1)

DLC1 comes as standard with the SDL1X Advanced and is an optional accessory for the SDL1X Standard.

 "4.1 Basic Key Operation"

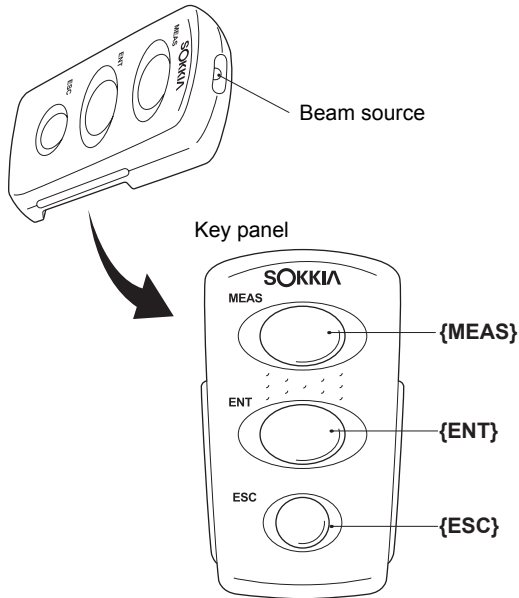

The SDL is operated from the Remote trigger by pointing the Remote trigger beam at the SDL and pressing the required operation keys.

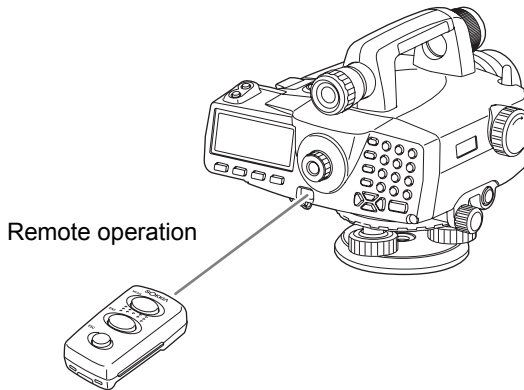

- When sunlight shines directly into the Beam detector on the SDL, remote operation with the Remote trigger may not work correctly.

#### 4. BASIC OPERATION

---

- If other DLC1-compatible SOKKIA instruments are turned ON and placed within the operating range of the Remote trigger, they may be unintentionally operated at the same time.
- Do not place the keyboard under heavy objects or in a tight space. A key may be continuously depressed and deplete battery power.
- Working duration shortens under low temperatures.

|               |   |
|---------------|---|
| <b>{MEAS}</b> | Performs same operation as Measure key on the SDL |
| <b>{ENT}</b>  | Same operation as <b>{←}</b> on SDL               |
| <b>{ESC}</b>  | Same operation as <b>{ESC}</b> on SDL             |

## 4.2 Display Functions

### Status screen

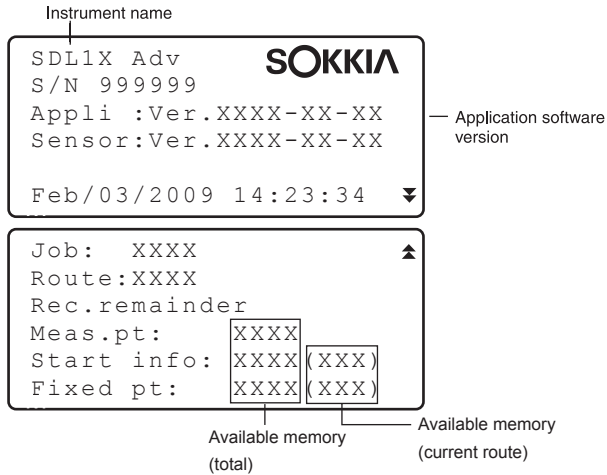

### Meas Mode screen



### Input screen

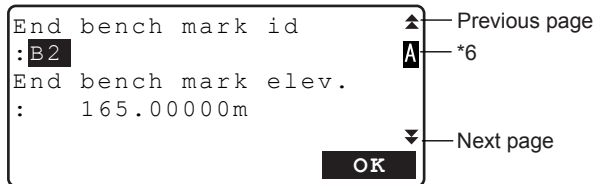

\*1 Rh: Staff reading (height)

\*2 Hd: Horizontal distance to staff

\*3 Measurement mode

S: Single

R: Repeat

A: Average

T: Rapid

\*4 Remaining battery power (BDC58, Temperature=25°C)

■ ■ ■ : level 3 Full power.

■ ■ □ : level 2 Plenty of power remains.

■ □ □ : level 1 Half or less power remains.

□ □ □ : level 0 Little power remains. Prepare replacement battery where available.

#### 4. BASIC OPERATION

---

"Battery low! Please charge battery." (with audio tone) displayed alternately with current screen  
: No power remains.

Stop measurement and save data. Then turn the instrument off and charge the battery.

 "5.1 Battery Charging"

##### \*5 Bluetooth communication status

: Connection established

[ (flashing): Waiting

[x (flashing): Disconnecting

[x: SDL Bluetooth device is OFF

##### \*6 Input mode

A :Inputting capital letters

a :Inputting small letters

:Inputting numeric characters

# 5. USING THE BATTERY

Types of power source: "19. POWER SUPPLY SYSTEM"

## 5.1 Battery Charging

The battery was not charged at the factory. Charge the battery fully before using the SDL.



- The charger will become rather hot during use. This is normal.
- Do not use to charge batteries other than those specified.
- The charger is for indoor use only. Do not use outdoors.
- Batteries cannot be charged, even when the charging lamp is flashing, when the temperature is outside the charging temperature range.
- Remove batteries from the charger before putting into storage.
- When not in use, disconnect the power cable plug from the wall outlet.

### ►PROCEDURE

1. Connect the power cable (EDC113A/113B/113C) to the charger (CDC68) and plug the charger into the wall outlet.
2. Mount the battery (BDC58/46B) in the charger by matching the grooves on the battery with the guides on the charger.

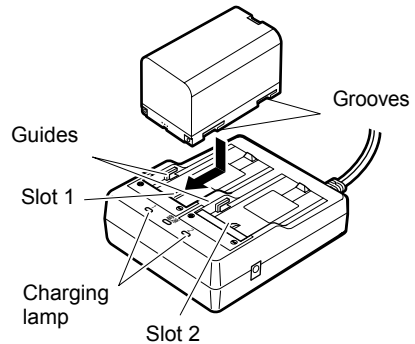

3. When charging starts, the lamp starts blinking.
4. The lamp lights when charging is finished.
5. Remove the battery and unplug the charger.

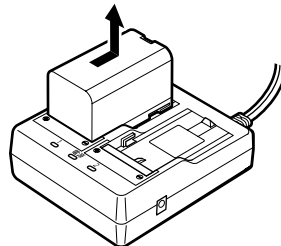

## 5. USING THE BATTERY

---



- Slots 1 and 2:  
The charger starts charging the battery mounted first. If you place two batteries in the charger, the battery in slot 1 is charged first, and then the battery in slot 2. (☞ step 2)
- Charging lamp:  
The charging lamp is off when the charger is outside the charging temperature range or when the battery is mounted incorrectly. If the lamp is still off after the charger falls within its charging temperature range and the battery is mounted again, contact your local dealer. (☞ steps 2 and 3)
- Charging time per battery (at 25°C):  
BDC58:                      about 4 hours  
(Charging can take longer than the times stated above when temperatures are either especially high or low.)

### 5.2 Installing/Removing the Battery

Mount the charged battery.

BDC46B and battery adapter SB178 are optional accessories.



- Before removing the battery, turn off the power to the instrument. Settings, and file and folder data may be lost if the battery is removed while the power is switched on.
- When installing/removing the battery, make sure that moisture or dust particles do not come in contact with the inside of the instrument.
- Remove batteries from the instrument or charger before putting into storage.
- Store the battery in a dry room where the temperature is within the following ranges

| Storage period      | Temperature range |
|---------------------|-------------------|
| 1 week or less      | -20 to 50°C       |
| 1 week to 1 month   | -20 to 45°C       |
| 1 month to 6 months | -20 to 40°C       |
| 6 months to 1 year  | -20 to 35°C       |

For long-term storage, the battery should be charged at least once every six months.

- The BDC58 generates power using a chemical reaction and as a result has a limited lifetime. Even when in storage and not used for long periods, battery capacity deteriorates with the passage of time. This may result in the operating time of the battery shortening despite having been charged correctly. In this event, a new battery is required.



### ►PROCEDURE Mounting the battery

1. Push the catch on the battery cover away from the objective lens.

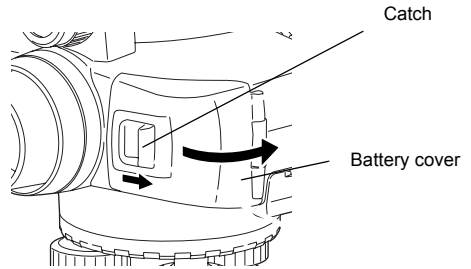

2. Insert the battery in the direction of the arrow on the side of the battery.
3. Close the battery cover. A click is heard when the cover is secure.

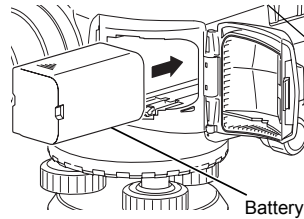

### ►PROCEDURE Removing the battery

1. Push the catch on the battery cover away from the objective lens.
2. Push the release lever down. Grip the battery and slide out.



- If the release lever is not pushed down completely when removing the BDC46B, the battery adapter may jam against the release lever. In this event, push the lever down fully and remove, or re-insert the battery into the instrument and try removing again.

3. Close the battery cover. A click is heard when the cover is secure.

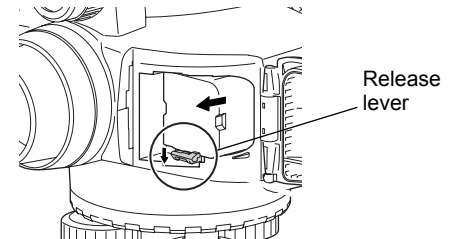

### ► PROCEDURE Using the Battery adapter

---

Insert the BDC46B into the battery adapter (SB178). The battery can now be mounted in the same way as the BDC58.

1. Align the notch in the BDC46B with the SB178 as shown at right. With the terminals-end of the battery inserted, push until the battery adapter is fully extended.

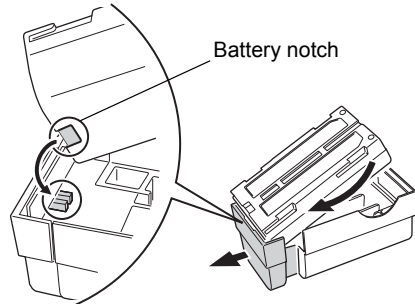

2. Slot the top end of the battery into the battery adapter. The extendable portion of the battery adapter will automatically retract and hold the battery in place.

#### Note

- To remove, grip both sides of the battery towards the terminals-end and pull out.
- It is possible to charge the BDC46B without removing from the battery adapter.

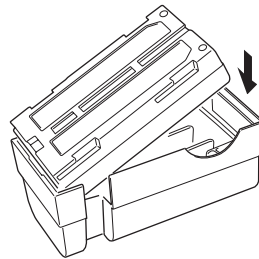

# 6. SETTING UP THE INSTRUMENT



- Mount the battery in the instrument before performing this operation because the instrument will tilt slightly if the battery is mounted after leveling.

## 6.1 Setting Up

### ►PROCEDURE

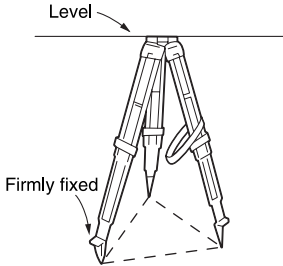
1. Make sure the legs are spaced at equal intervals and the head is approximately level. Set the tripod so that the head is positioned over the survey point. Make sure the tripod shoes are firmly fixed in the ground.  

2. Place the instrument on the tripod head. Supporting with one hand, tighten the centering screw on the bottom of the unit to make sure it is secured to the tripod.

## 6.2 Leveling

Instrument can also be levelled using the screen.

 "Note" Leveling on the screen"

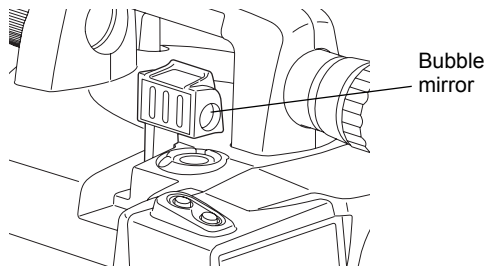
The mirror can be used to check the position of the bubble in the tube when it cannot be viewed from above..



## 6. SETTING UP THE INSTRUMENT

### ► PROCEDURE Leveling with the Spherical head tripod

1. Loosen the centering screw.
2. Slide the instrument across the tripod head until the bubble is centered in the circular level.
3. Tighten the centering screw.
4. Level the SDL using the leveling foot screws.

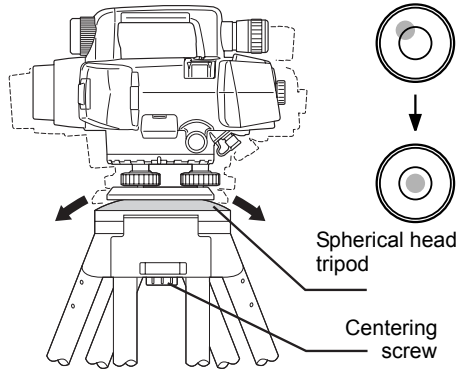

### ► PROCEDURE Leveling with the Flat head tripod

1. Center the bubble in the circular level by either shortening the tripod leg closest to the offcenter direction of the bubble or by lengthening the tripod leg farthest from the offcenter direction of the bubble.
2. Adjust one more tripod leg until the bubble is roughly centered.
3. Turn the leveling foot screws while checking the circular level until the bubble is exactly centered in the center circle. When you turn a screw clockwise, raising the instrument, the bubble will move towards the position of that screw.

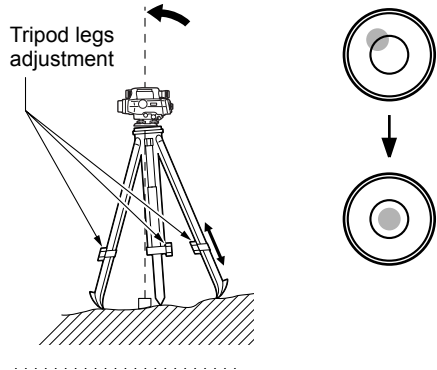

## ►PROCEDURE Leveling on the screen

1. Turn the instrument on.  
 "7. POWER ON/OFF"
2. The screen shown at right is displayed.

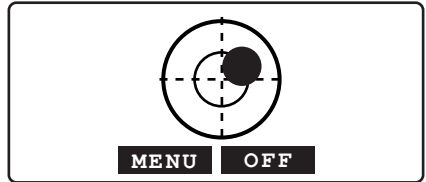

3. Center "●" in the circular level.  
 "6.2 Leveling PROCEDURE Leveling with the Spherical head tripod/"6.2 Leveling PROCEDURE Leveling with the Flat head tripod"  
 "●" indicates the bubble in circular level. The range of the inside circle is 12' and the range of the outside circle is 24'.
  - Press **[OFF]/[BEEP]** to turn the the audio tone OFF/ON.

### Note

- Measurement cannot be performed when the Tilt screen is displayed.
- The tilt screen is automatically displayed on startup when "Tilt warn" in "Obs.condition" is set to "Yes" and the instrument tilt exceeds the allowable range. Set to "No" to skip levelling on startup.  
 "Tilt warn." setting: "16.2 Instrument Configuration"
- Pressing **[MENU]** in the screen shown above returns the screen to <Menu> without completing leveling. However, measurement cannot be performed until the instrument is levelled.

# 7. POWER ON/OFF

## ► PROCEDURE Power ON

1. Press {  }.

When the power is switched on, a RAM check is run. The Meas mode screen is displayed.

If the tilt screen is displayed, the instrument tilt sensor is indicating that the instrument is out of level. Level the instrument once again and the Meas mode screen will be displayed.



### Note

- The tilt screen is automatically displayed on startup when "Tilt warn" in "Obs.condition" is set to "Yes" and the instrument tilt exceeds the allowable range. Set to "No" to skip levelling on startup.
- Do not remove the battery while the SOKKIA logo is displayed.
- "Tilt warn." in "Obs. condition" should be set to "No" if the display is unsteady due to vibration or strong wind.



 "16.1 Observation Conditions"



### Resume function

The Resume function redisplay the screen appearing before the instrument was powered OFF when the instrument is powered back ON. All parameter settings are also saved. This function is only activated when the power is turn off while performing height difference measurement or checks and adjustments. When powering back on the screen is returned to the beginning of the procedure being performed on power OFF.

## ► PROCEDURE Power OFF

Press {  } while pressing {  }.



- When there is almost no battery power remaining, "Battery low! Please charge battery." (with audio tone) is displayed alternately with current screen. In this event, stop measurement, switch off the power and charge the battery or replace with a fully charged battery. Data and settings may be lost if the battery is removed while the power is on.
- To save power, power to the SDL is automatically cut off if it is not operated for a fixed period of time. This time period can be set to "30 min." or "No" in "Power off" in "Instr.config".

 "16.2 Instrument Configuration"

## 7.1 Resolving Software Issues

If you are experiencing problems with the SDL and suspect a fault in the software, you should try resetting. If the problem is not resolved the next step is to initialize data.

 "16.6 Restoring Default Settings"



- Be sure to back up stored data to an external memory device or computer in advance.

### ►PROCEDURE Initializing data

1. Power OFF the instrument.
2. Press {  } while holding {BS}, {F1}, and {F3} until the SOKKIA logo appears. "Clearing memory..." is displayed and data is initialized. The instrument then powers on as normal.

# 8. FOCUSING AND SIGHTING THE STAFF

## 8.1 Using the SDL1X Advanced



- If the view finder sighting axis is not aligned with the sighting axis of the objective lens, errors will occur when taking measurements. Always make sure the axes are correctly aligned when using the view finder.
- The View finder can be used to sight staffs at distances of 7m or more.
- Focussing can also be performed manually by turning the focusing knob while looking through the eyepiece. If the staff barcodes are out of focus, they will not be readable and measurements cannot be taken. Make sure they are correctly focused.
- Even when Auto Focus has finished the image in the telescope eyepiece may appear out of focus depending on the eyesight of the operator.



### View finder and Auto Focus function

The view finder is used when aligning the SDL telescope with the staff. Simply aligning the two center circles in the view finder with the center of the staff and pressing the Measure key automatically focuses the SDL on the staff and starts measurement reducing operator workload and increasing operator efficiency in the field.

### ► PROCEDURE Always perform before using the instrument

1. Look through the telescope at a bright and featureless background.
2. Looking through the eyepiece, turn the eyepiece screw clockwise, then counterclockwise little by little until just before the reticle image becomes focussed.  
Using these procedures, frequent reticle refocussing is not necessary since your eye is focussed at infinity.
3. Looking through the telescope, shift your eyes slightly up and down and to each side. If the staff and reticle show no deviation, the instrument is ready for use.  
If the staff and reticle deviate, return to step 2.
4. Sight a clear vertical line, such as the wall of a building, at a distance usually used for operation.

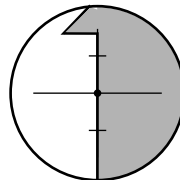
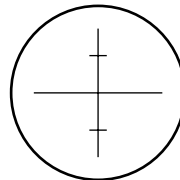

5. Turn the horizontal fine motion knobs until that vertical line is centered in the field of view.



- Looking through the view finder, turn the view finder eyepiece screw until the 2 circles are focussed.
- Use the view finder axis alignment screw to align the 2 circles in the view finder with the same vertical line described in step 4. The sighting axis of the view finder is now aligned with the sighting axis of the telescope as seen through the eyepiece.

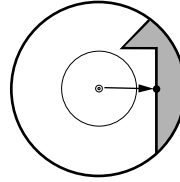

### Eliminating parallax

This is the relative displacement of the target image with respect to the reticle when the observer's head is moved slightly before the eyepiece.

Parallax will introduce reading errors and must be removed before observations are taken. Parallax can be removed by refocussing the reticle.

## ►PROCEDURE Using Auto Focus to focus on the staff

---

- Turn the instrument on.  
 "7. POWER ON/OFF"
- Aim the objective lens roughly in the direction of the staff.
- Use the horizontal fine motion knobs to align the 2 circles in the view finder until the staff is approximately centered.

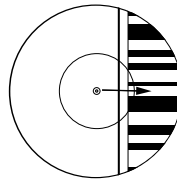

- Press the Measure key. The instrument automatically focuses on the staff and measurement starts.

## 8.2 Using the SDL1X Standard



- If the staff barcodes are out of focus, they will not be readable and measurements cannot be taken. Make sure they are correctly focused.

### ► PROCEDURE

1. Look through the telescope at a bright and featureless background.
2. Looking through the eyepiece, turn the eyepiece screw clockwise, then counterclockwise little by little until just before the reticle image becomes focussed. Using these procedures, frequent reticle refocussing is not necessary since your eye is focussed at infinity.

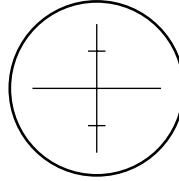

3. Use the Simple Finder to point the objective lens at the staff.

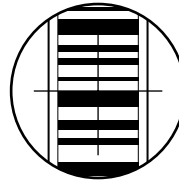

4. Turn the horizontal fine motion knobs until the staff is nearly centered in the field of view, then turn the focusing knob to focus on the staff.
5. Looking through the telescope, shift your eyes slightly up and down and to each side. If the staff and reticle show no deviation, the instrument is ready for use. If the staff and reticle deviate, return to step 2.

"8.1 Using the SDL1X Advanced Eliminating parallax"



- Repeat steps 3 and 4 each time measurement is performed.

# 9. CONNECTING TO EXTERNAL DEVICES

The SDL can be connected to a data collector to allow remote operation. Read this manual in conjunction with the operator's manual for the relevant external device and software thereof.

## 9.1 Wireless Communication using *Bluetooth* Technology

The *Bluetooth* module incorporated in the SDL can be used for communication with *Bluetooth* devices such as data collectors.



- Connection settings are returned to factory settings when defaults are restored. Perform settings again after restoring defaults.



### **Bluetooth connections**

Communication between a pair of *Bluetooth* devices requires one device to be set as the "Master" and the other as the "Slave". SDL is always the "Slave" device. Connections are initiated from the paired device side

### ►PROCEDURE Necessary settings for *Bluetooth* communication

1. Select "Config" in <Menu>.

```
Menu
1.Meas
2.Management
3.Config
```

2. Select "Comms setup" in <Config menu>.

```
Config menu
1.Obs.condition
2.Instr.config
3.Comms setup
4.Tilt offset
5.Unit
```

3. Select "Bluetooth" in "Mode".

```
Mode :Bluetooth
Authenticate:No

STX/ETX (CSV) :No
INFO
```

4. Set "Authenticate" to "Yes" or "No".  
If "Authenticate" is set to "Yes" for the SDL the passkey will also need to be input on the companion device.

## 9. CONNECTING TO EXTERNAL DEVICES

---



5. When "Authenticate" is set to "Yes", input the same passkey as that for the intended companion device. Even if "Authenticate" is set to "No", a passkey is requested when authentication is set on the companion device being used.

Up to 16 numeral characters can be input. Input characters will be displayed as asterisks (e.g. "\*\*\*\*\*"). The passkey was set to "0123" at the factory.

```
Mode           :Bluetooth
Authenticate: Yes
Passkey
:*****
STX/ETX (CSV) :No
```

**INFO**

6. Set STX/ETX (CSV) settings

 "16.3 Communication Setup"  STX/  
ETX (CSV)"

### ► PROCEDURE Displaying *Bluetooth* information for the SDL

---

1. Select "Config" in <Menu>
2. Select "Comms setup" in <Config menu>
3. Select "Bluetooth" in "Mode" and press **[INFO]**.

```
Mode           :Bluetooth
Authenticate:No

STX/ETX (CSV) :No
```

**INFO**

The *Bluetooth* information for the SDL is displayed. The "BD\_ADDR" for the SDL must be registered on your *Bluetooth* device.

```
Bluetooth ID
: Bxxxxxxx, Bxxxxxxx
Firmware Ver. x.x.x
BD_ADDR
: 00:AA:BB:CC:DD:FF
```



**OK**



#### **Bluetooth Device Address**

This is a number unique to one particular *Bluetooth* device used to identify devices during communication. This number consists of 12 characters (numbers 0 to 9 and letters from A to F). Some devices may be referred to by their *Bluetooth* device address.

## 9.2 Establishing a connection between the SDL and paired Bluetooth device

When "Mode" is set to "Bluetooth" in "Comms setup" in <Config menu> [  |  ] is displayed in Meas mode.

### ►PROCEDURE

1. Complete the necessary settings for *Bluetooth* communication.

 "9.1 Wireless Communication using Bluetooth Technology"

2. Press [  ] in the second page of Meas mode screen.

The *Bluetooth* module in the SDL powers on and connection starts.

The *Bluetooth* icon indicates communication status.

 "4.2 Display Functions"



### Note

- Softkeys (in Meas mode)

[  ]:Press to enter waiting status

[  ]:Press to cancel the connection/exit waiting status

- Audio tones

(While connecting/disconnecting)

Start paging/waiting:

short beep

Connection successfully established:

long beep

Connection canceled/being canceled:

two short beeps

## 9.3 Communication between the SDL and Companion Device

Setting a data collector as the companion device allows measurement and other operations to be performed from the data collector side.



- *Bluetooth* communication causes SDL battery power to be depleted at a rate higher than that for normal operation.
- Check that the companion device (data collector etc.) is turned on and the relevant *Bluetooth* settings are complete.

### ► PROCEDURE

---

1. Complete the necessary settings for *Bluetooth* communication.  
☞ "9.1 Wireless Communication using Bluetooth Technology"
2. Check communication status.  
☞ "9.2 Establishing a connection between the SDL and paired Bluetooth device"
3. Initiate measurement using the paired *Bluetooth* device (e.g. a data collector). SDL will respond and measurement will start. Measured values are then displayed in the Meas mode screen.

### 9.4 Outputting data using *Bluetooth* communication

It is possible to set a computer as the companion device and output JOB data and route data via wireless communication.

### ► PROCEDURE Outputting JOB data to a host computer

---

1. Complete the necessary settings for *Bluetooth* communication.  
☞ "9.1 Wireless Communication using Bluetooth Technology"
2. Check communication status.  
☞ "9.2 Establishing a connection between the SDL and paired Bluetooth device"
3. Select "Comms output" in <JOB menu> and set "Com.locat."  
☞ "15.1 Outputting JOB Data PROCEDURE Outputting JOB data to host computer"  
SDL starts outputting data.

```
Job id
  JOB1
Format      CSV_1

Outputting      98 / 99
```

- If a connection has not yet been established, the screen at right is displayed. After a connection has been established, the data is output.

Bluetooth



Waiting for  
connection...

### 9.5 Connecting via Communication Cable

---

#### ►PROCEDURE Basic cable settings

---

1. Connect the SDL to the external device using the cable.  
 Cables: "21. OPTIONAL ACCESSORIES"
2. Select "Comms setup" in <Config menu>. Set communication conditions.  
 "16.3 Communication Setup"

# 10. BASIC OPERATION

## 10.1 Reading the Staff

Simply focus on the RAB\* code for an automatic reading of the staff. The following explains how to read the RAB code of the staff.

\*RAB code (RANdom Bi-directional code) is a coded staff used with SOKKIA digital levels.



- Set up the staff in an area free of obstacles.
- Avoid placing the staff next to mirror-like surfaces. The effect of strong light could make measurements impossible.
- Support the staff so that it is perpendicular, checking the circular bubble scope on the staff. If the staff is tilting, height and distance measurements will be incorrect.
- If the surface is catching the light, turn it just enough to stop the reflection.

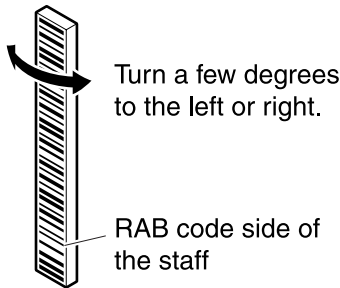

- Make sure shadows are not cast on the staff as this could make measurement impossible.
- When holding the staff during measurement, make sure your hand does not cover the RAB code.
- If dark locations make measurement difficult, shine a flashlight on the staff. Stand at a distance so that the beam shines evenly over the length of the staff.
- If waterdrops or dirt adhere to the barcode, measurement may be impossible. Wipe the staff clean with a soft cloth.
- Clean the staff if grit or dirt gets stuck between the sections. If the staff is dirty, measurements will not be very accurate.
- Avoid scratching or soiling the barcode surface as this could make measurement impossible. Store and carry the staff inside its case.
- If the SOKKIA BIS/BGS series staff is used for leveling, and the height difference and temperature difference are much larger than normal, temperature variations may cause the staff to expand or contract and cause differences in relative height measurements. SDL reads in measurements up to 0.01mm and minor deviations in the accuracy of the staff will adversely affect accuracy. To obtain high accuracy measurements, it is important to perform temperature corrections for the staff. See **Note** below.

### Note

- Formula for correcting expansion and contraction of the staff due to temperature changes.

$$\Delta C = \{C_0 + (T - T_0) \times \alpha\} \times \Delta h$$

$\Delta C$ : Staff correction value

$C_0$ : Scale factor

T: Measured temperature during observation (average)



temperature during measurement of known site,  
intermediate site, new site)

$T_0$ : Reference temperature of 20 ° C

$\alpha$  : Line expansion coefficient

$\Delta h$ : Height difference

### ►PROCEDURE Setting up the staff

---

1. Set the foot plate on the ground so that the staff will not sink.
2. When using a BGS staff, connect the sections correctly by making sure the numbers on the numeric scale side of the staffs run in unbroken order.
3. Keeping an eye on the circular bubble scope on the staff, set the staff in the foot plate so that it stands up straight.
4. Turn the barcode scale towards the instrument.

### ►PROCEDURE Measuring the height from a ceiling

---

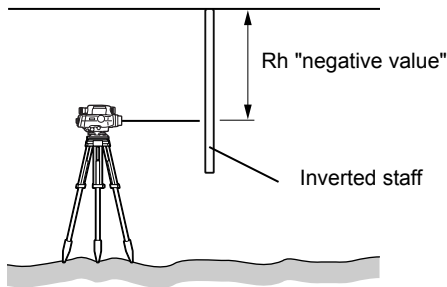

## 10.2 Measuring in Measure Mode

In Measure mode you can sight point A, take the staff reading Rh, and measure the horizontal distance Hd to the staff.

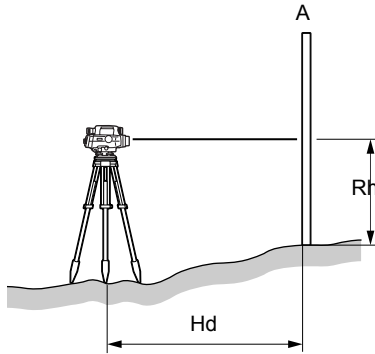

- If direct sunlight or strong light enter the eyepiece during measurement, ambient light is too low, or the staff is set against a background which is too bright, and measurement cannot be performed, an error is displayed (  "17. WARNING AND ERROR MESSAGES").
- If the SDL or staff is subjected to shocks or vibration during use, measurement may be impossible. Resume measurement during more stable conditions.

### ► PROCEDURE

1. Turn the instrument on.  
 "7. POWER ON/OFF"
2. Aim the instrument at the staff and press the Measure key. Measurement starts. When measurement is complete, the staff readings (Rh) and horizontal distance (Hd) are displayed.

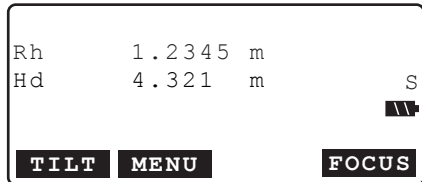

- In Repeat, Average, or Rapid mode, values are renewed with each measurement. Press **[STOP]** or the Measure key to stop reading. Press **{ESC}** to cancel the reading.



- Auto focus functionality is not available for the SDL1X Standard. Therefore **[FOCUS]** is not displayed in the screen of step 2.

# 11.HEIGHT DIFFERENCE MEASUREMENT

Height difference measurement allows the user to calculate the relative height between a known point and a specified point. The instrument is moved from bench mark to bench mark along a route from the known point to the unknown point taking measurements at each section. The total of measurements at all sections gives the height difference between the known point and the specified point. This method is particularly useful when the known and unknown points are far apart, relative height is great, or there are obstacles preventing sighting.

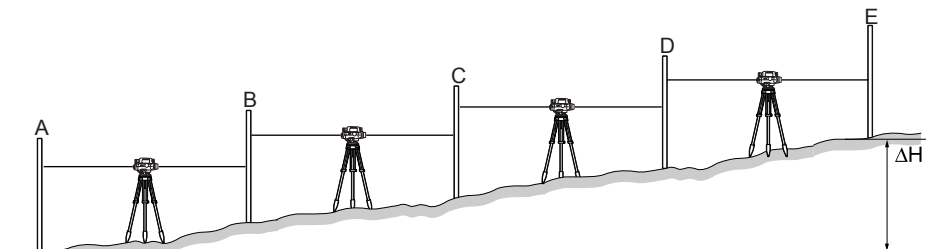

- Except when special circumstances exist, there should be an even number of sections along a route.

## 11.1 Route Setup

The route between benchmark and benchmark must be set before starting measurement. Select an existing route or create a new route.

- Route setup is performed in <Route menu>.
- It is possible to select a partially completed route and recommence measurement from where you left off.
- When performing double-run leveling, each run is treated as a separate route.
- It is possible to change the route ID and memo of routes containing measurement data (except when rec. location is set to "& SD").
- The maximum number of routes per JOB is 100.  
The maximum number of fixed points/end points per route is 100 (2000 total in all routes incl. fixed points/end points)  
The maximum number of start conditions per route is 100 (1000 total in all routes incl. start conditions)

### ►PROCEDURE Selecting a route

1. Select "Meas" in <Menu>.

```
Menu
1.Meas
2.Management
3.Config
```

## 11. HEIGHT DIFFERENCE MEASUREMENT

---

2. Select "Height dif." in <Meas menu>.

```
Meas menu
1.Height dif.
2.Check & adjust.
```

3. Select "Route" in <Height dif. menu>.

```
Height dif. menu
1.Route
2.Measurement
```

4. The currently selected route is displayed.  
Press **[LIST]**. Align the cursor with the desired route name and press **{←}**.

```
Route setting
:R1
```

**LIST** **NEW** **DETAIL** **OK**

• **[NEW]**: Press to set a new route.  
 "PROCEDURE Recording a new route"

• **[DETAIL]**: Press to display route settings.  
Route name can also be changed.

 "PROCEDURE"

• **[↑↓...P]** = Use **{▲}**/**{▼}** to move from page to page.

• **[↑↓...P]** = Use **{▲}**/**{▼}** to select individual point.

• Press **[TOP]** to move to the first point number on the first page.

• Press **[LAST]** to move to the last point number on the last page.

```
R1          20
R2          20
LINE01     15
LINE02     10
LINE03     0
```

**↑↓...P** **TOP** **LAST**

5. Press **[OK]** to confirm route settings.

```
Route setting
:R2
```

**LIST** **NEW** **DETAIL** **OK**

### ►PROCEDURE Recording a new route

---

1. Select "Meas" in <Menu>.

2. Select "Height dif." in <Meas menu>.

3. Select "Route" in <Height dif. menu>.

4. Press **[NEW]**.

Route setting  
:R1

**LIST** **NEW** **DETAIL** **OK**

5. Set the following data items.

- (1) Route ID
- (2) Memo
- (3) Start bench mark ID
- (4) Start bench mark elevation
- (5) End bench mark ID
- (6) End bench mark elevation
- (7) Double-run setting
- (8) Measurement order
- (9) Measurement procedure
- (10) Ht resolution
- (11) Distance resolution
- (12) Rh range
- (13) dH range
- (14) Upper tolerance (distance)
- (15) Lower tolerance (distance)
- (16) Upper tolerance (ht)
- (17) Lower tolerance (ht)
- (18) Distance difference between backsight and foresight
- (19) Total distance difference between backsight and foresight

Route id  
: R1 **A**

Memo  
:  
:

**OK**

Start bench mark id **▲**  
:B1

Start bench mark elev.  
: 150.00000m **▼**

**OK**

End bench mark id **▲**  
:B2

End bench mark elev.  
: 165.00000m **▼**

**OK**

Line :Go **▲**  
Order :1

Meas.Proc:BFFB **▼**

**OK**

Ht reso. :0.1mm **▲**  
Dist reso.:0.001m

Rh range : 0.50mm  
dH range : 1.00mm **▼**

**OK**

Upper dist 40.00 m **▲**  
Lower dist: 3.000 m

Upper Rh : 2.80000m  
Lower Rh : 0.20000m **▼**

**OK**

## 11. HEIGHT DIFFERENCE MEASUREMENT

```
BF dist diff.
: 1.000 m
Total dist diff.
: 3.000 m
OK
```

6. Press **[OK]** in the screen of step 5 when all data items have been set.  
Press **[YES]** in the subsequent screen to confirm route settings.

```
New route setting
is registered.
Confirm?
NO YES
```

### Note

Conditions such as character input restrictions, input range, and selectable options for the above data items are as follows.

- Route ID/benchmark ID: up to 16 characters
- Memo: 2 rows of up to 16 characters
- Elevation: -20000.00000 to 20000.00000m
- Double-run setting: Go/Return
- Measurement order: 1/2/3/4/5 (each number is allocated to a commonly used measurement procedure making selection of a measurement procedure easier. This allocation is saved in the set route)
- Measurement procedure: BFFB/BBFF/BF/aBFFB/aFBBF/BFBF/aBF ("B" means backsight and "F" means foresight, "a" signifies alternation of measurement procedure at subsequent bench mark)
- Ht resolution: 0.01/0.1/1mm
- Distance resolution: 0.001/0.01/0.1m
- Ht/Distance range: 0.00 to 99.99mm ("0.00" setting: no restrictions on this data item)
- Upper/Lower tolerance (distance): 0.000 to 200.000m ("0.000" setting: no restrictions on this data item)
- Upper/Lower tolerance (ht): 0.00000 to 9.99999m ("0.00000" setting: no restrictions on this data item)
- Distance difference between backsight and foresight/Total distance difference between backsight and foresight: 0.000 to 200.000m ("0.000" setting: no restrictions on this data item)

## ►PROCEDURE Editing route ID

1. Select "Route" in <Height dif. menu>.
2. Press **[LIST]**. Align the cursor with the desired route and press **{←}**.

Route setting  
:R1

**LIST** **NEW** **DETAIL** **OK**

3. Press **[DETAIL]**.
4. Edit the memo/route ID and press **[OK]** to confirm.
  - Data items other than memo/route ID for routes containing measurement data cannot be edited.

Route id  
: R1 A

Memo  
:  
:  
:

**OK**

## 11.2 Height Difference Measurement

Each section along the set route is measured using the backsight/foresight sequence selected in the "Meas. Proc." data item in route settings. Fixed points can be established along the route while measuring.

- Power to the instrument can be turned off while moving between sections. The Resume function maintains measurement results obtained prior to shutdown.
- When "Rec cond." is set to "Yes", start conditions must be set when starting measurement of a new route.



### Fixed points

When checking the accuracy of measurement results, fixed points common to both the go and return runs are set. Fixed points are also set when stopping measurement temporarily.

## 11. HEIGHT DIFFERENCE MEASUREMENT

### ► PROCEDURE Measurement procedure BFFB

1. Select "Meas" in <Menu>.
2. Select "Height dif." in <Meas menu>.
3. Select "Measurement" in <Height dif. menu>.

```
Height dif. menu
1.Route
2.Measurement
```

4. Select "Start cond." in <Meas menu>.
  - Select "Meas start" to skip Start cond. input and proceed to step 7.

```
Height dif. meas menu
1.Start cond.
2.Meas start
3.View
```

5. Set the following data items.
  - (1) Temperature
  - (2) Weather
  - (3) Wind strength
  - (4) Wind direction
  - (5) Observer name
  - (6) Memo

```
Feb/17/2009 10:03:28
Temp      : 15.0 °C
Weather   : Fine
Wind      : Calm
Wind dir  : ---
```

OK

6. Press **[OK]** in the screen of step 5 when all data items have been set.

```
Observer
```

```
: [REDACTED]
```

```
Memo
```

```
:
```

```
:
```

OK

7. Set up the SDL in the center of the first section.
8. Press the Measure key to perform pre-measurement and confirm that the distance to the backsight is approximately the same as the distance to the foresight. Press **[OK]**.

```
Pre.meas.
```

```
Rh      1.2345 m
```

```
Hd      34.567 m
```

OK

TILT

CNFG

OK

FOCUS



9. Measure backsight.

- **[FOCUS]**: Press to perform Auto Focus only.
- **[PT.ID]**: Press to change the point ID.

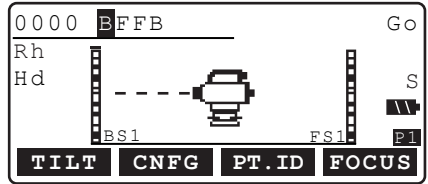

- **[CNFG]**: Press to configure measurement settings.

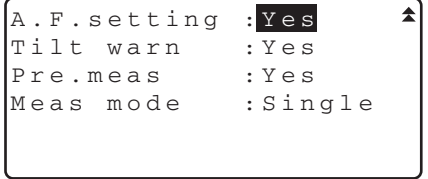

- Press **[INPUT]** on page 2 to manually input Rh values and Hd values obtained using the telescope stadia lines.

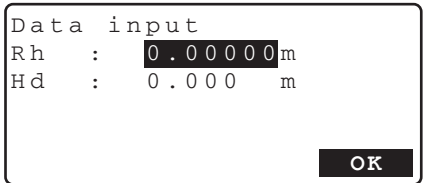

10. Check point ID, double-run setting, and measurement results. Press **[OK]**.

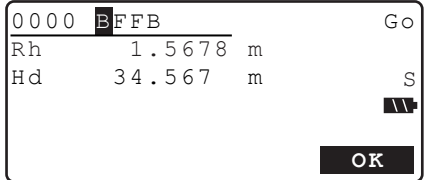

11. Measure foresight.

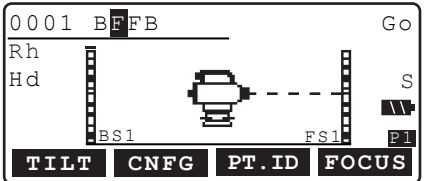

12. Check point ID, double-run setting, and measurement results. Press **[OK]**.

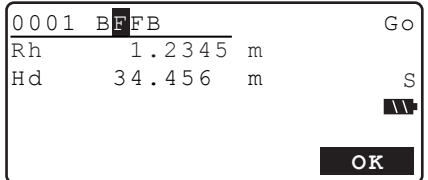

## 11. HEIGHT DIFFERENCE MEASUREMENT

13. Measure foresight again and check results.
14. Measure backsight again and check results.

15. The following results are displayed for the first section.

Relative height difference between first and second measurements  
 Height difference  
 Distance between backsight and foresight  
 Distance from previous fixed point  
 Distance from first point  
 Relative height difference from previous fixed point  
 Relative height difference from first point  
 Elevation of foresight point

|   |          |     |    |        |     |    |
|---|----------|-----|----|--------|-----|----|
| 0001  |          | Go  |    |        |     |    |
| h1  | 0.3333 m |     |    |        |     |    |
| h2  | 0.3331 m |     |    |        |     |    |
| Dif.  | 0.2 mm   |     |    |        |     |    |
| D   | 69.023 m | ▼   |    |        |     |    |
| <table border="1"> <tr> <td>IS</td> <td>FIXEDP</td> <td>END</td> <td>OK</td> </tr> </table> |          |     | IS | FIXEDP | END | OK |
| IS  | FIXEDP   | END | OK |        |     |    |

Press **[OK]** to record results and display the measurement screen for the next measurement point.

|   |           |     |    |        |     |    |
|---|-----------|-----|----|--------|-----|----|
| Σd  | 69.023 m  | ▲   |    |        |     |    |
| ΣD  | 69.023 m  |     |    |        |     |    |
| Σh  | 0.3332 m  |     |    |        |     |    |
| ΣH  | 0.3332 m  |     |    |        |     |    |
| Z   | 20.3332 m |     |    |        |     |    |
| <table border="1"> <tr> <td>IS</td> <td>FIXEDP</td> <td>END</td> <td>OK</td> </tr> </table> |           |     | IS | FIXEDP | END | OK |
| IS  | FIXEDP    | END | OK |        |     |    |

- Press **[IS]** to measure from the current point to a point not on the route.

When **[IS]** is pressed, measurement results for the current section are recorded and the screen shown at right is displayed.

Press the Measure key to measure the IS point.

Press **[OK]** in the screen shown at right to record results and return to the previous screen.

Measurements of subsequent IS points can be performed from this screen.

Press **{ESC}** to exit IS measurement.

|  |      |       |       |      |       |       |
|--|------|-------|-------|------|-------|-------|
| 0002   | IS   | Go    |       |      |       |       |
| Rh   |      | S     |       |      |       |       |
| Hd   |      | ▲▼    |       |      |       |       |
| <table border="1"> <tr> <td>TILT</td> <td>CNFG</td> <td>PT.ID</td> <td>FOCUS</td> </tr> </table> |      |       | TILT  | CNFG | PT.ID | FOCUS |
| TILT   | CNFG | PT.ID | FOCUS |      |       |       |

|  |           |    |    |
|--|-----------|----|----|
| 0002   | IS        | Go |    |
| Rh   | 1.3456 m  |    |    |
| Hd   | 30.123 m  | S  |    |
| Z  | 19.7778 m | ▲▼ |    |
| <table border="1"> <tr> <td>OK</td> </tr> </table> |           |    | OK |
| OK   |           |    |    |

16. Set up the SDL in the center of the next section.

17. Repeat steps 8 to 15 to measure the subsequent sections. The foresight for the previous section becomes the backsight for the current section.

- Press **[FIXEDP]** in the screen of step 15 to set up a fixed point. Input a temperature and memo and press **[OK]** to proceed the next screen.

|   |                 |     |    |
|---|-----------------|-----|----|
| Fixed pt No.0003  |                 |     |    |
| Feb/17/2009 10:33:28  |                 |     |    |
| Temp  | : [REDACTED] °C |     |    |
| Memo  | :               |     |    |
| <table border="1"> <tr> <td>END</td> <td>OK</td> </tr> </table> |                 | END | OK |
| END   | OK              |     |    |

Press **[END]** then **[YES]** in the screen shown at right to end height difference measurement and return to <Height dif. meas menu>.

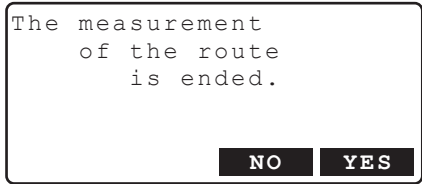

18. Check the results for the final section.  
Press **[END]** in the results screen for the final section.

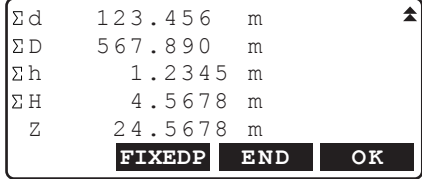

19. Set temperature and enter a memo.  
Press **[OK]** to record results and end height difference measurement.  
<Height dif. meas menu> is restored.

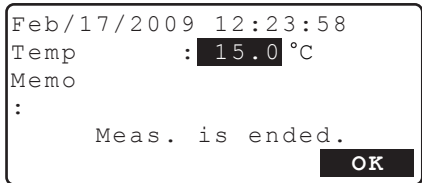

**Note**

- Start cond. input in steps 4 to 5 is optional when restarting measurement of a partially-completed route.
- The pre-measurement of step 8 will be performed in rapid single mode regardless of the "Meas mode" setting in "Obs.condition".
- Auto focus functionality is not available for the SDL1X Standard. Therefore **[FOCUS]** is not displayed in the screen of steps 8, 9 and 11.

Conditions such as character input restrictions, input range, and selectable options for the above data items are as follows.

- Temperature: -30 to 60°C (-22 to 140°F)
- Weather: Fine/Cloudy/Light rain/Rain/Light snow/Snow/Fog
- Wind strength: Calm/Gentle/Light/Strong/Very strong
- Wind direction: ---/N/NE/E/SE/S/SW/W/NW
- Observer name: up to 16 characters
- Memo: 1 or 2 rows of up to 16 characters

# 12. OTHER MEASUREMENT FUNCTIONS

## 12.1 Measuring Horizontal Angle

You can measure the horizontal angle between point A and point B by using the horizontal circle.

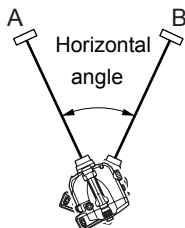

## 12.2 Using the Instrument as a Standard Level

By using the numeric scale side of the staff, you can use the SDL as a standard level. Simply focus on the staff using the eyepiece and read the scale.

In the Height difference measurement mode, manually sighted Rh values and distance values (Hd) measured using the stadia lines can be manually input in the currently selected route by pressing **[INPUT]** in the second softkey page of the backsight/foresight measurement screens.

 "11.2 Height Difference Measurement" step 9

### Note

- The instrument can be used as a standard level regardless of whether the power is on or off. However, pressing the Measure key when the power is on will result in an error.

# 13.SELECTING/DELETING A JOB

## 13.1 Selecting a JOB

- A total of 20 JOBS have been prepared, and JOB1 was selected when your SDL was shipped from the factory.
- The names of the JOBS have been preset as JOB1 to JOB20; you can change them to any names you wish.
- JOB ID can be edited (except when "Rec locat." set to "&SD").

### ►PROCEDURE

1. Select "Management" in <Menu>.

```
Menu
1.Meas
2.Management
3.Config
```

2. Select "JOB" in <Management menu>. <JOB menu> is displayed.

```
Management menu
1.JOB
2.Route
```

3. Select "JOB selection" in <JOB menu>.

```
Job menu
1.JOB selection
2.JOB deletion
3.Comms output
```

4. Press **[LIST]**.  
Align the cursor with the desired JOB and press **{←}**.  
The JOB is determined and <JOB menu> is restored.
  - The numbers to the right represent the number of data items in each JOB.
  - Press **[EDIT]** to edit JOB ID.

```
Job setting
:JOB1
```

**LIST**

**EDIT**

**OK**

### Note

- The list of JOB names is contained on up to 4 pages.
- Maximum length of JOB name: 16 (alphanumeric) characters.

## 13.2 Deleting a JOB

It is possible to clear the data within a designated JOB. After the data has been cleared, the JOB name returns to the name allocated when the SDL was shipped.



- A JOB (containing a route) that has not been output to an external device cannot be deleted.

### ► PROCEDURE

1. Select "Management" in <Menu>.

```
Menu
1.Meas
2.Management
3.Config
```

2. Select "JOB" in <Management menu>. <JOB menu> is displayed.

```
Management menu
1.JOB
2.Route
```

3. Select "JOB deletion".

```
Job menu
1.JOB selection
2.JOB deletion
3.Comms output
```

4. Align the cursor with the desired JOB and press {←}.  
↓

```
JOB1 20
JOB2 20
JOB3 15
JOB4 10
JOB5 54 ↓
↑↓...P TOP LAST
```

5. Press [YES]. The data within the JOB selected is deleted and the JOB list is restored.

```
Job deletion

JOB1
deletion
Confirm ?
NO YES
```

# 14.ROUTE SETTINGS

## 14.1 Deleting a Route

It is possible to delete a route or routes within the current JOB.



- A route that has not been output to an external device (displayed with \*) cannot be deleted.

### ►PROCEDURE

1. Select "Management" in <Menu>.

```
Menu
1.Meas
2.Management
3.Config
```

2. Select "Route" in <Management menu>. <Route menu> is displayed.

```
Management menu
1.JOB
2.Route
```

3. Select "Route deletion".

```
Route menu
1.Route setting
2.Route deletion
3.Comms output
4.View
```

4. Align the cursor with the desired route and press {←}. "DEL" is displayed next to the route ID.

- The numbers to the right represent the number of data items in each route.
- [↑↓...P] = Use {▲}/{▼} to move from page to page.
- [↑↓...P] = Use {▲}/{▼} to select individual point.
- Press [TOP] to move to the first point number on the first page.
- Press [LAST] to move to the last point number on the last page.

```
*R1 20
R2 20
LINE01 15
LINE02 10
LINE03 DEL ▼
↑. . . P TOP LAST OK
```

5. Press [OK].

## 14. ROUTE SETTINGS

- Press **[YES]**. The route is deleted and the route list is restored.

```
Route deletion
Route setting
deletion
Confirm?
NO YES
```

### 14.2 Displaying Route Information

It is possible to review data saved within the selected route.

- Route data review is performed in <Route menu>.

#### ► PROCEDURE

- Select "Management" in <Menu>.
- Select "Route" in <Management menu>. <Route menu> is displayed.
- Select "View".

```
Route menu
1.Route setting
2.Route deletion
3.Comms output
4.View
```

- A list of start information and fixed points is displayed in the order in which they were observed. Align the cursor with the desired measurement point and press **{←}**.

- "Start info": Start conditions input before height difference measurement. Multiple "Start info" data may exist when a route measurement has been interrupted and restarted.
- "fixed pt.": Data and details obtained when setting a fixed point during height difference measurement.

```
Start info.1
fixed pt.1
fixed pt.2
fixed pt.3
Start info.2
↑...P TOP LAST ↓
```

- Align the cursor with the desired start info./IS point (only when IS results recorded)/fixed pt./ measurement point and press **{←}**.

```
Start info.2
0010->0011
->1000
fixed pt.4
0011->0014
↑...P TOP LAST ↓
```



Detailed information regarding the selected data item is displayed.

The displayed screen differs depending on the type of data selected. The screen shown at right displays data for the measurement point selected in step 5.

|      |        |      |    |
|------|--------|------|----|
| 0014 |        |      | Go |
| h1   | 0.3333 | m    |    |
| h2   | 0.3331 | m    |    |
| Dif. | 0.2    | mm   |    |
| D    | 48.642 | m    | ▼  |
| NEXT |        | PREV |    |

- **[PREV]**: Press to display detailed information for the previous data item.
- **[NEXT]**: Press to display detailed information for the next data item.

6. Press **{ESC}** to restore previous screens.

# 15.OUTPUTTING DATA

It is possible to output JOB and route data to a host computer or external memory device.

 Bluetooth communication: "9.4 Outputting data using Bluetooth communication"

Communication cables: "21. OPTIONAL ACCESSORIES"

Output format and command operations: "Command Explanations" manuals.

- Communication setup can also be performed in <JOB menu> and <Route menu>.

## 15.1 Outputting JOB Data

- Only 1 JOB can be output at a time.
- JOB information, observation conditions, route information, observation data, start conditions, foresight information and notes are output.

### ►PROCEDURE Outputting JOB data to host computer

1. Connect the SDL and host computer.

2. Select "Management" in <Menu>.

```
Menu
1.Meas
2.Management
3.Config
```

3. Select "JOB" in <Management menu>.

```
Management menu
1.JOB
2.Route
```

4. Select "Comms output".

```
JOB menu
1.Route setting
2.Route deletion
3.Comms output
4.View
```

5. Select format from "CSV 1" or "CSV 2".

```
Format :CSV_1
Com.locat.:Com
```

6. Check that "Com. locat." is set to "Com".

7. Press [OK].

- [COMM]: Press to display the communication setup screen.

 "16.3 Communication Setup"

COMM

OK

8. Align the cursor with the JOB to be output and press **{←}**.

- The numbers to the right represent the number of data items in each JOB.
- "\*" means the JOB has not been output to an external device yet.

|        |                        |
|--------|------------------------|
| *JOB1  | 99                     |
| JOB2   | 20                     |
| JOB3   | 15                     |
| JOB4   | 10                     |
| JOB5   | 54                     |
| ↑↓...P | <b>TOP</b> <b>LAST</b> |

9. Output starts.

- Press **{ESC}** to cancel output.

10. Press **{ESC}** to return when "Completion" is displayed.

```
Job id
  JOB1
Format      CSV_1

Outputting   98 / 99
```

### ►PROCEDURE Outputting JOB data to an SD card

1. Open the external interface hatch cover.

2. Insert an SD card into the SD card slot.

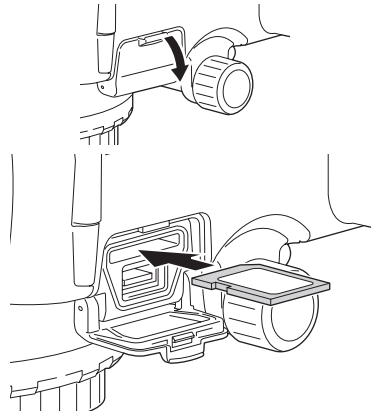

3. Select "JOB" in <Management menu>.

4. Select "Comms output".

5. Select format from "CSV 1" or "CSV 2".

6. Check that "Com. locat." is set to "SD".

7. Press **[OK]**.

```
Format      : CSV 1
Com.locat. : SD

COMM      OK
```

8. Align the cursor with the JOB to be output and press **{←}**.

9. Enter a file name and press **[OK]**.

## 15. OUTPUTTING DATA

---

10. Output starts.



- Do not remove the SD card or turn off the SDL while files are being copied/transferred.

11. Press **{ESC}** to return when "Completion" is displayed.

### Note

- SD cards up to 2GB supported. SDHC not supported.

## ► PROCEDURE Outputting JOB data to a USB memory device

---

1. Open the external interface hatch cover.

2. Insert a USB memory device into the USB port.

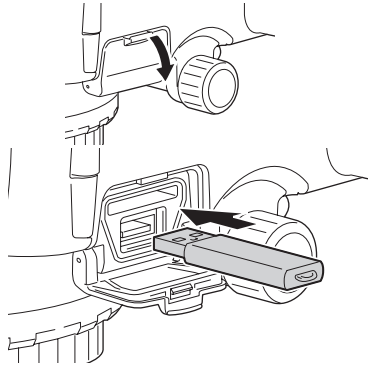

3. Select "JOB" in <Management menu>.

4. Select "Comms output".

5. Select format from "CSV 1" or "CSV 2".

6. Check that "Com. locat." is set to "USB".

7. Press **[OK]**.

8. Align the cursor with the JOB to be output and press **{←}**.

9. Enter a file name and press **[OK]**.

10. Output starts.





- Do not disconnect the USB memory or turn off the SDL while files are being copied/transferred.

11. Press **{ESC}** to return when "Completion" is displayed.

### Note

- Start cond. input in steps 4 to 5 is optional when restarting measurement of a partially-completed route.
- Conditions such as character input restrictions, input range, and selectable options for the above data items are as follows.  
Output format: CSV\_1 (output of measurement results by instrument station for all measurements)/ CSV\_2 (measurement results by instrument station split into foresight and backsight before output. elevation and dH values output in foresight data)  
Com.locat.: Com (output to connected device via RS232C or *Bluetooth* wireless technology depending on "Mode" setting)/SD/USB
- USB memory devices up to 4GB supported.

## 15.2 Outputting Route Data

### ►PROCEDURE Outputting route data to host computer

1. Connect SDL and host computer by attaching the communication cable to the Multi Port.
2. Select "Route" in <Management menu>.
3. Select "Comms output".
4. Select format from "CSV 1" or "CSV 2".
5. Check that "Com. locat." is set to "Com".
6. Press **[OK]**.

```
Management menu
1.JOB
2.Route
```

```
Route menu
1.Route setting
2.Route deletion
3.Comms output
4.View
```

## 15. OUTPUTTING DATA

---

7. Select the route ID to be output and press **{←}**.

"OUT" appears to the right of the route ID selected. You can select as many route IDs as you want.

- The numbers to the right represent the number of data items in each route.
- "\*" means the route has not been output to an external device yet.

|        |     |         |
|--------|-----|---------|
| 1      |     | OUT     |
| 2      |     | OUT     |
| ROUTE  | 11  | 26      |
| *ROUTE | A22 | 44      |
| ↓      |     |         |
| ↑↓...P | TOP | LAST OK |

8. Press **[OK]**.

9. Output starts.

- Press **{ESC}** to cancel output.

10. Press **{ESC}** to return when "Completion" is displayed.

|            |         |
|------------|---------|
| Route id   | 1 / 2   |
| 1          |         |
| Format     | CSV_1   |
| Outputting | 56 / 78 |

### ► PROCEDURE Outputting route data to an SD card

---

1. Open the external interface hatch cover.
2. Insert an SD card into the SD card slot.
3. Select "Route" in <Management menu>.
4. Select "Comms output".
5. Select format from "CSV 1" or "CSV 2".
6. Check that "Com. locat." is set to "SD".
7. Press **[OK]**.
8. Select the route ID to be output and press **{←}**.  
"OUT" appears to the right of the route ID selected. You can select as many route IDs as you want.  
  
"\*" means the route has not been output to an external device yet.
9. Press **[OK]**.

10. Enter a filename and press **[OK]**.

11. Output starts.



- Do not remove the SD card or turn off the SDL while files are being copied/transferred.

12. Press **{ESC}** to return when "Completion" is displayed.

### **►PROCEDURE Outputting route data to a USB memory device**

---

1. Open the external interface hatch cover.
2. Insert a USB memory device into the USB port.
3. Select "JOB" in <Management menu>.
4. Select "Comms output".
5. Select format from "CSV 1" or "CSV 2".
6. Check that "Com. locat." is set to "USB".
7. Repeat steps 7 to 12 in "PROCEDURE Outputting route data to an SD card"



- Do not disconnect the USB memory or turn off the SDL while files are being copied/transferred.

# 16.CHANGING THE SETTINGS

This section explains the contents of parameter settings, how to change these settings, and how to restore default settings.

Each item can be changed to meet your measurement requirements.

Config menu

1. **Obs.condition**  
2. Instr.config  
3. Comms setup  
4. Tilt offset  
5. Unit

Config menu

6. Date and time

Instrument constants are explained in a different chapter.

 "18.2 Tilt Sensor", "18.3 Adjusting the Reticle"

## 16.1 Observation Conditions

Meas mode : **Single**

Rec cond. : Yes  
Rec locat. : Internal  
Ht reso. : 0.01mm  
Dist reso. : 0.001m

C&R

: **No**  
A.F.setting : Yes  
Tilt warn : Yes

### Items set and options (\*: Factory setting)

Measurement mode (Meas mode): Single\*, Repeat, Average, Rapid

AVG times (only displayed when: 1 to 20

"Average" selected above)

Rec cond.: Yes\*, No

Rec location. (only displayed when: & SD/Internal\*

"Yes" selected above)

Height resolution (Ht. reso.): 0.01mm/0.0001ft\*, 0.1mm/0.001ft, 1mm/0.01ft

Distance resolution (Dist reso.): 0.001m/0.01ft\*, 0.01m/0.1ft, 0.1m/1ft

Earth curvature and refraction correction (C&R):

No\*, K=0.142, K=0.20

Auto Focus setting. (A.F.setting): Yes\*, No

Tilt warning (Tilt warn): Yes\*, No



- "Rec cond." and "Rec locat." cannot be changed for a JOB already containing route data.



- There is no "A.F. setting" for the SDL1X Standard.



## 16.2 Instrument Configuration

```
Power off      : 30min
Contrast      : 10
```

### Items set and options (\*: Factory setting)

Power off : No, 30min.\*  
 Contrast: 0 to 15 (10\*)



### Power-saving automatic cut-off

To save power, power to the SDL is automatically cut off if it is not operated for 30 minutes.

## 16.3 Communication Setup

```
Mode          : RS232C
Baud rate     : 1200bps
Parity        : Not set
Xon/Xoff      : No
STX/ETX (CSV) : No
```

### Items set and options (\*: Factory setting)

Mode: RS232C\*, *Bluetooth*  
 Baud rate: 1200\*, 2400, 4800, 9600, 19200, 38400, 57600bps  
 Parity: Not set\*, Odd, Even  
 Xon/Xoff: Yes, No\*  
 STX/ETX (CSV): Yes, No\*



Control commands and communication formats: Interface Format Explanations SDL1X Edition  
 and Output Formats and Command Explanations SDL Edition  
 Setting "Mode" to "Bluetooth": "9.3 Communication between the SDL and Companion Device"



### STX/ETX (CSV)

This setting is relevant only when "Com.locat." is set to "Com".

When this setting is set to "Yes", a "start of text" (STX) code is added to the start, and an "end of text" (ETX) code to the end of output text data.

When "Com.locat." is set to "SD" or "USB", no STX or ETX is added.

## 16.4 Units

```
Temp.           : °C
Angle unit      : degree
Dist unit       : meter
```

### Items set

Temperature: °C\*, °F  
Angle unit: degree\*, gon, mil  
Distance unit: meter\*, feet  
Feet (only displayed when "feet" selected above): Int. feet\*, US feet



- "Temp.", "Dist unit", and "Feet" cannot be changed for a JOB already containing route data.

## 16.5 Date and Time

```
Date and time

Date: Mar/04/2009
Time: 084059

OK
```

### Items set

Date: Manually input date. (format: MMDDYYYY)  
e.g. March 20, 2009 is input as "03202009".  
Time: Manually input time.  
e.g. 2:43:59 pm is input as "144359".



### Date and Time

The SDL includes a clock/calendar function.

## 16.6 Restoring Default Settings

A reset is necessary in order to restore set items to default settings.



- The resume function is cancelled when a reset is performed. Finish height difference measurement and reticle adjustment before performing a reset.
- Restoring set items to default settings will not erase stored data. However, if the data in the memory is important, **BE SURE TO BACK UP STORED DATA TO AN EXTERNAL MEMORY DEVICE OR COMPUTER IN ADVANCE.**
- If a JOB contains a route, "Rec cond." and "Rec locat." in "Obs. condition", "Temp" and "Dist unit" settings will not be reset even when a reset is performed.

### ►PROCEDURE Performing a reset

1. Turn the instrument off.
2. Press {⏻} while holding {BS}, and {F4} until the SOKKIA logo appears.  
"Default set" is displayed and the instrument is reset.
3. Power the instrument on as normal.

# 17. WARNING AND ERROR MESSAGES

The following is a list of the error messages displayed by the SDL and the meaning of each message. If the same error message is repeated or if any message not shown below appears, the instrument has malfunctioned. Contact your local dealer.

## **Adj. range exceeded**

The adjustment range for reticle adjustment (CCD line sensor) has been exceeded, or checks have been performed incorrectly.

Checks and adjustments can be performed but confirm correct procedure beforehand.  
Contact your local dealer if this message is displayed again.

## **Approaching adj. limit**

The adjustment range for reticle adjustment (CCD line sensor) is about to be reached, or checks have been performed incorrectly.

Confirm correct procedure.

Stop checks and contact your local dealer if this message is displayed again.

## **Bad condition**

The instrument is subject to excessive vibrations or hot conditions are producing shimmer.

## **Bluetooth device error!**

Either the instrument you are using is not equipped with *Bluetooth* functionality or the *Bluetooth* device in the SDL is malfunctioning.

Contact your local dealer if this message is displayed again.

## **Bluetooth setting error!**

*Bluetooth* connection configuration failed.

Perform configuration again. Contact your local dealer if this message is displayed again.

## **Brightness error**

Something obscured the staff or the brightness level suddenly altered during measurement.

## **Dist. over !**

The distance you are trying to measure is outside the range (Upper dist - Lower dist) set in route settings.

## **File deletion error!**

An error occurred while trying to delete a file.

Initialize data after first outputting all necessary data.

 "7.1 Resolving Software Issues"

## **File open error!**

An error occurred while trying to open a file.

When trying to write to a USB device, check that the USB is not read-only.

Contact your local dealer.

## **File read error!**

An error occurred while trying to read in a file.

Contact your local dealer.

**File system error!**

**File write error!**

It is impossible to read in/write data.

When trying to write to a USB device, check that the USB is not read-only.

Otherwise, contact your local dealer.

**Fixed pt record full!**

No more fixed points can be recorded.

Delete unnecessary JOB or route data and try again.

**Fixed pt record full in current route!**

No more fixed points can be recorded in the current route.

**Focusing error**

Something obscured the staff during Auto Focus, the brightness level suddenly altered. or the SDL was subjected to large vibrations resulting in a poor focus condition.

**Hd diff. over !**

The measured distance is outside the range (BF dist diff.) set in route settings.

**Ht-diff. over !**

The difference in relative height over the 2 measurements is outside the range (dH range) set in route settings.

**Lower dist is greater than upper dist!**

The value set in Lower dist is greater than the value set in upper dist value.

**Lower Rh is greater than upper Rh!**

The value set in Lower Rh is greater than the value set in upper Rh value.

**Max route num.**

The maximum number of routes (100) has been reached.

Try again after deleting unnecessary routes.

**Meas. error**

An object other than the staff is being sighted.

The staff is out of focus.

The staff is partly unreadable because obscured by an obstacle or is damaged.

The staff is too close or too far away.

A shadow is falling on part of the staff.

The staff was incorrectly sighted.

Light is entering the eyepiece.

Use your hand or body to shield the eyepiece from the light source.

**Meas.pt record full!**

No more meas. points can be recorded.

Delete unnecessary JOB or route data and try again.

**Memory connection err!**

External memory device not connected correctly.

## 17. WARNING AND ERROR MESSAGES

---

### **Memory full!**

The external memory device became full before output finished.

Output the data again after deleting unnecessary data from the memory device, or use a new memory device.

### **Memory write protect!**

External memory device is write protected. Data cannot be written to the external memory device.

### **No data**

No data exists in the current route.

### **No JOB id**

No JOB ID input.

### **No route**

No route exists in the current JOB.

### **No route id**

No route ID input. Input a route ID.

### **No route setting**

Route settings have not been made.

### **No SD card inserted.**

No SD card inserted in the SD card slot. Check that the SD card is inserted correctly.

  SD card slot

### **No staff**

No staff detected by the Auto Focus function.

Make sure that the staff is sighted correctly.

### **No start cond. setting**

Start cond. settings for height difference measurement have not been made.

### **Rec cond. setting < No > Start cond. input unnecessary.**

"Rec cond." set to "No". Even if start conditions are input they will not be recorded.

To record start conditions, set "Rec cond." to "Yes".

### **Rh diff. over !**

The difference in staff reading (height) over the 2 measurements is outside the range (Rh range) set in route settings.

### **Rh out of range !**

The staff reading (height) is outside the range (Upper Rh - Lower Rh) set in route settings.

### **Same file id**

The filename input already exists.

Select a different filename.

### **Same job id**

The job ID input already exists.

Select a different job ID.

**Same route id**

The route ID input already exists.  
Select a different route ID.

**SD card files are read-only**

Data on the SD card is read only. Files cannot be deleted, changed, or overwritten.

**SD card is write protected.**

SD card is write protected. Data cannot be written to the SD card. Cancel write protection or use a different SD card.

**SD card record is stopped. Continue?**

Data cannot be written to the SD card despite "Rec cond." being set to "& SD", perhaps because the SD card is not inserted correctly.

Press **[YES]** to write data to the internal memory only (subsequent recording to the SD card will not be possible for this route).

**SD card record is stopped.**

Data cannot be written to the SD card despite "Rec cond." being set to "& SD", perhaps because the SD card is not inserted correctly. Writing to the SD card has been cancelled.

**Sigma Hd diff. over!**

The total difference in foresight and backsight distance is outside the range (Total dist diff.) set in route settings.

**Staff too far**

Move the staff to within the measuring range distance.

 "22. SPECIFICATIONS"

**Start info.record full!**

No more start info. can be recorded.

Delete unnecessary JOB or route data and try again.

**Start info.record full in current route!**

No more start info. from the current route can be recorded.

**The battery for the clock function needs to be replaced.**

The voltage of the lithium battery has decreased, the battery itself is depleted, and the date/time display is incorrect.

An error will occur temporarily on the lithium battery when the instrument is powered on using a battery with little remaining power. In this event, re-configure the date/time settings

 "16.5 Date and Time"

When a message is constantly displayed upon startup the lithium battery needs to be replaced. For details on replacing lithium batteries contact your local dealer.

**The capacity of the SD card is insufficient.**

Remaining memory capacity of the SD card is not enough to save data. Insert a new SD card or delete unnecessary data from the current SD card.

## 17. WARNING AND ERROR MESSAGES

---

### **The capacity of the USB is insufficient.**

Remaining memory capacity of the USB memory device is not enough to save data. Insert a new device or delete unnecessary data from the current device

### **The following cannot be used in a file id.**

A file name containing "\*", "?", or "/" is invalid. Create a file name which does not use any of these characters.

### **Time out**

The Auto Focus function could not read the staff, or Auto Focus could not complete within the time specified. Check the staff is set up correctly and try again.

### **Too bright**

Too bright. The brightness level suddenly altered during measurement.  
Something is shining nearby or behind the staff.  
Light is entering the eyepiece.

Use your hand or body to shield the eyepiece from the light source.

### **Too dark**

Too dark. The brightness level suddenly altered during measurement.

### **USB files are read-only.**

Data on the USB memory device is read only. Files cannot be deleted, changed, or overwritten.

### **USB memory device is write protected.**

USB memory device is write protected. Data cannot be written to the USB memory device.  
Cancel write protection or use a different device.

### **USB memory device not inserted.**

No USB memory device inserted in the USB port.  
Check that the USB memory device is inserted correctly.



# 18.CHECKS AND ADJUSTMENTS

SDL is a precision instrument that requires fine adjustments. It must be inspected and adjusted before use so that it always performs accurate measurements.

- Always perform checking and adjustment in the proper sequence beginning from "18.1 Circular Level" to "18.3 Adjusting the Reticle".
- In addition, the instrument should be inspected with special care after it has been stored a long time, transported, or when it may have been damaged by a strong shock.
- Make sure the instrument is securely set up and stable before performing checks and adjustments..

## 18.1 Circular Level

Check and adjust it as outlined below.



- Be careful that the tightening tension is identical for all the adjusting screws.
- Also, do not over-tighten the adjusting screws as this may damage the circular level.

### ►PROCEDURE Checking and adjusting

1. Adjust the leveling foot screws until the bubble is centered in the circle.

 "6.2 Leveling steps 3 to 5"

2. Turn the instrument 180°. The bubble should not shift from the center. If the bubble does move, adjust as follows.

3. Compensate for one-half of the shift by adjusting the leveling foot screws.

4. Eliminate the remaining shift by turning the circular level adjusting screws with the hexagonal wrench until the bubble is centered.

5. Turn the instrument 180°. If the bubble stays in the center, adjustment is complete. If the bubble moves, repeat steps 3 and 4.

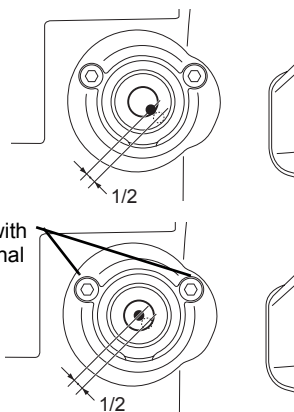

## 18.2 Tilt Sensor

If the tilt angle shifts from tilt angle 0° (zero point), the instrument is not correctly levelled. The actual circular level and graphic level will not be displayed correctly. Perform the following procedure to cancel the tilt zero point error.

### ►PROCEDURE Checking and adjusting

1. Carefully level the SDL. If necessary, repeat the procedures to check and adjust the circular level.
2. Select "Config" in <Menu>.
3. Select "Tilt offset" in <Config menu> to display the current correction constant in the X (sighting) direction and Y (horizontal axis) direction.

```
Config menu
1.Obs.condition
2.Instr.config
3.Comms setup
4.Tilt offset
5.Unit
```

```
Tilt offset

Current X 403 Y 399

ADJUST
```

4. Press **[ADJUST]** to display the tilt angle in the X (sighting) direction and Y (horizontal axis) direction.
5. Wait a few seconds for the display to stabilize, then read the automatically compensated F1 angles (X1 and Y1).

```
Tilt adjustment
X      0'40"
Y      1'45"

Take F1

OK
```

6. Press **[OK]** and rotate the top of the instrument and 180° while referring to the horizontal circle.

7. Wait a few seconds for the screen to stabilize, then read the automatically compensated F2 angles (X2 and Y2).

```
Tilt adjustment
X      0'25"
Y     -1'30"
```

8. In this state the following offset values (tilt zero point error) are calculated.

$$X_{\text{offset}} = (X1 + X2)/2$$

$$Y_{\text{offset}} = (Y1 + Y2)/2$$

Take F2

**OK**

If one of the values ( $X_{\text{offset}}$ ,  $Y_{\text{offset}}$ ) exceeds  $\pm 1'$ , adjust the value using the following procedure.

When the offset value falls within the range  $\pm 1'$ , adjustment is not necessary.

Press **{ESC}** to return to <Config menu>.

9. Press **[OK]** and rotate the top of the instrument and  $180^\circ$  while referring to the horizontal circle.
10. If the new correction constants are within the range  $400 \pm 50$ , press **[YES]** or **{←}** to renew the correction angle. <Config menu> is restored.

```
Tilt offset
Current X403 Y399
New      X405 Y401
```

If the values exceed the adjustment range, select **[NO]** to cancel the adjustment and restore <Tilt offset>. Contact your local dealer to perform the adjustment.

**NO**

**YES**

## ►PROCEDURE Recheck

11. Select "Tilt offset" in <Config menu>.
12. Wait a few seconds for the display to stabilize, then read the automatically compensated F3 angles (X3 and Y3).
13. Press **[OK]** and rotate the top of the instrument and  $180^\circ$  while referring to the horizontal circle.
14. Wait a few seconds for the display to stabilize, then read the automatically compensated F4 angles (X4 and Y4).
15. In this state the following offset values (tilt zero point error) are calculated.

$$X_{\text{offset}} = (X3 + X4)/2$$

$$Y_{\text{offset}} = (Y3 + Y4)/2$$

## 18. CHECKS AND ADJUSTMENTS

---

When both offset values fall within the range  $\pm 1'$ , adjustment is complete.

Press **{ESC}** to return to <Config menu>.

If one of the offset values (Xoffset, Yoffset) exceeds  $\pm 1'$ , repeat the check and adjustment procedures from the beginning. If the difference continues to exceed  $\pm 1'$  after repeating the check 2 or 3 times, have your local dealer perform the adjustment.

## 18.3 Adjusting the Reticle

The reticle cross-lines can be corrected if out of adjustment. While reading the staff RAB-code, adjust the reticle by correcting the reference value of the CCD line sensor and then make mechanical adjustments to the instrument.



- As described in the following procedure, high accuracy readings are obtained by taking repeat readings of the staff.

### ►PROCEDURE Correcting the reference value of the CCD line sensor

- Select "Meas" in <Menu>.

```
Menu
1. Meas
2. Management
3. Config
```

- Select "Check & adjust."

```
Meas menu
1. Height dif.
2. Check & adjust.
```

- Place staffs a and b approximately 30m apart and set the instrument halfway between the staffs (position A).
- Perform pre-measurement of staffs a and b to check they are both approximately 15m from the instrument. Press **[OK]** to confirm.

```
Pre.meas.
Rh
Hd
```

```

  15m   A   15m
  |-----|-----|
  a               b

```

**TILT** **CNFG** **OK** **FOCUS**

- Measure staff a.  
Measurement results are displayed.

```
A abba
Rh 1.00540 m
Hd 15.010 m S
```

**OK**

- Press **[OK]** to accept the results.

## 18. CHECKS AND ADJUSTMENTS

7. Measure staff b.

|    |         |   |           |
|----|---------|---|-----------|
| A  | abba    |   |           |
| Rh | 1.34560 | m |           |
| Hd | 15.080  | m | S         |
|    |         |   |           |
|    |         |   | <b>OK</b> |

8. Press **[OK]** to accept the results.

9. Measure staff b.

|    |         |   |           |
|----|---------|---|-----------|
| A  | abba    |   |           |
| Rh | 1.34560 | m |           |
| Hd | 15.080  | m | S         |
|    |         |   |           |
|    |         |   | <b>OK</b> |

10. Press **[OK]** to accept the results.

11. Measure staff a.

|    |         |   |           |
|----|---------|---|-----------|
| A  | abba    |   |           |
| Rh | 1.00540 | m |           |
| Hd | 15.010  | m | S         |
|    |         |   |           |
|    |         |   | <b>OK</b> |

12. Press **[OK]** to accept the results.

13. Move the instrument to a position approximately 3m from staff a along a straight line joining staffs a and b. The new position is B.

14. Perform pre-measurement of staffs a and b to check that a is approximately 3m from the instrument and b is approximately 33m from the instrument. Press **[OK]** to confirm.

|             |  |              |   |
|-------------|--|--------------|---|
| Pre.meas.   |  |              |   |
| Rh          |  |              |   |
| Hd          |  |              | S |
|             |  |              |   |
| <b>TILT</b> |  | <b>CNFG</b>  |   |
| <b>OK</b>   |  | <b>FOCUS</b> |   |

15. Repeat steps 5 to 12, sighting the two staffs and taking the readings.

16. Check the difference between the results and decide whether correcting the reference value of the sensor is required.  
 If the difference is 0.3mm or less, no adjustment is necessary.  
 If the difference is over 0.3mm, adjustment is necessary.

|            |           |
|------------|-----------|
| h1         | -0.34020m |
| h2         | -0.34000m |
| Dif.       | 0.20mm    |
| <b>NO</b>  |           |
| <b>YES</b> |           |

17. When adjustment is necessary, press **[YES]**.
  - Press **[NO]** if no adjustment is necessary.
18. Press **[YES]** in the confirmation dialog shown at right.
  - Press **[NO]** to cancel and return to <Meas menu>.
19. The instrument calculates and records the required reticle adjustment from the measurement results, and then returns to the menu selection.
20. Repeat steps 3 through 18. Make sure that the difference between the results is 0.3mm or less.

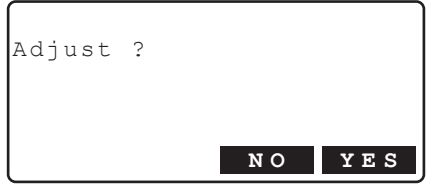

### ►PROCEDURE Mechanical adjustment

1. Sight the barcode face of staff b from position B and measure with the instrument.
2. Sight the scale face of staff b from position B and take a visual reading.
3. Check the difference between the measurements taken at steps 1 and 2. If necessary, adjust the cross-line as described below.
4. Remove the adjusting screw cover and insert a hexagonal wrench (M2.5) in the adjusting screw.
5. Turn the adjusting screw, then repeat steps 1 and 2. Adjust so that the difference between the two measurements is less than 2mm. If the measurement at step 2 is larger than the measurement at step 1, lower the cross-line by slightly loosening the adjusting screw. If the measurement at step 2 is smaller than the measurement at step 1, raise the cross-line by slightly tightening the adjusting screw.
6. Replace the adjusting screw cover.

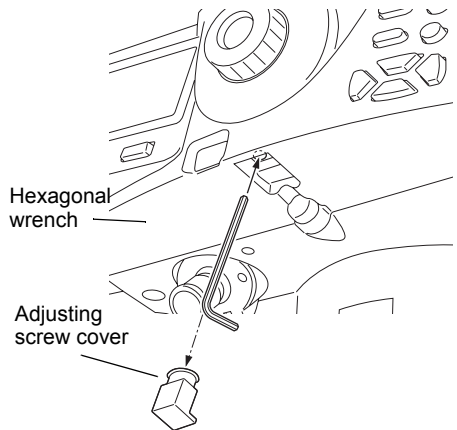
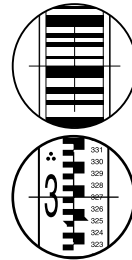



- When the instrument is powered off during reticle adjustment the resume function restores the following screen when the power is turned back on.
  - When powered off during measurement of point A: point A/staff a measurement screen
  - When powered off during measurement of point B: point B/staff a measurement screen
  - When powered off while displaying difference results: difference results screen
- Auto focus functionality is not available for the SDL1X Standard. Therefore **[FOCUS]** is not displayed in the screen of steps 4 and 14.



### Difference calculations

The difference value can be calculated as follows.

$$\text{Value at position A} = \frac{\{(1\text{st reading on staff a}) - (1\text{st reading on staff b})\} + \{(2\text{nd reading on staff a}) - (2\text{nd reading on staff b})\}}{2}$$

$$\text{Value at position B} = \frac{\{(1\text{st reading on staff a}) - (1\text{st reading on staff b})\} + \{(2\text{nd reading on staff a}) - (2\text{nd reading on staff b})\}}{2}$$

$$\text{Difference} = \text{absolute value of } [(value\ at\ position\ A) - (value\ at\ position\ B)]$$



# 19. POWER SUPPLY SYSTEM

Operate your SDL with the following combinations of power equipment.



- Never use any combination other than those indicated below. If you do, the SDL could be damaged.

Those indicated by \* are standard accessories. Others are optional accessories (sold separately).

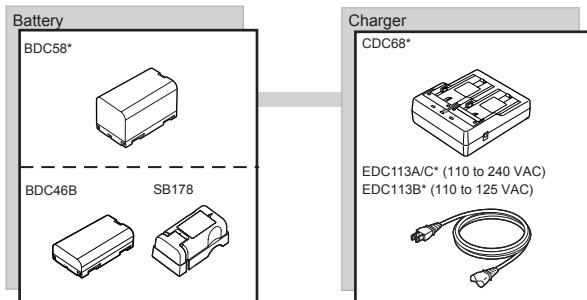

# 20. STANDARD EQUIPMENT

Please verify that all equipment is included.

## 20.1 SDL1X Advanced

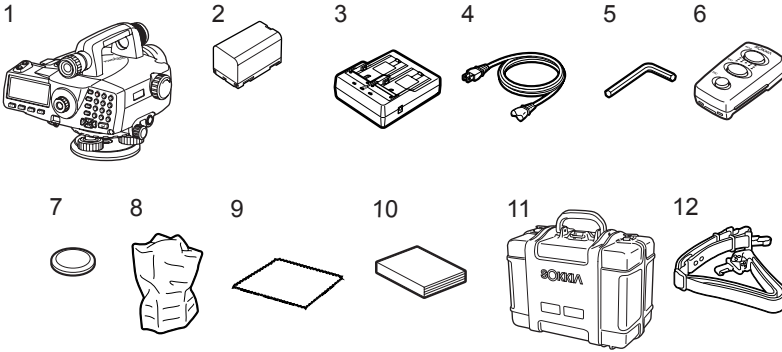

|    |   |   |
|----|---|---|
| 1  | SDL main unit   | 1 |
| 2  | Battery (BDC58)   | 1 |
| 3  | Battery charger (CDC68)   | 1 |
| 4  | Power cable (EDC113A/113B/113C)   | 1 |
| 5  | Hexagonal wrench (M2.5) (for both circular level and reticle adjustments) | 1 |
| 6  | Remote trigger (DLC1)   | 1 |
| 7  | Coin-type batteries (CR2032)  | 1 |
| 8  | Vinyl cover   | 1 |
| 9  | Cleaning cloth  | 1 |
| 10 | Operator's manual   | 1 |
| 11 | Carrying case (SC230)   | 1 |
| 12 | Carrying strap (SC96B)  | 1 |

**Note**

•Optional accessory DE28/29 can also be placed in the carrying case.

**● Remote Trigger (DLC1)**

Changing battery cells



- Remove the battery cells when the remote trigger is not to be used for a long time.

**►PROCEDURE**

1. Pull the catch on the battery cover down. Remove the battery cover.

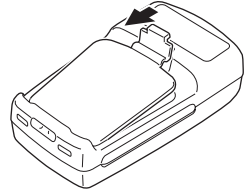

2. Slide the coin-type battery and press as shown at right to remove.

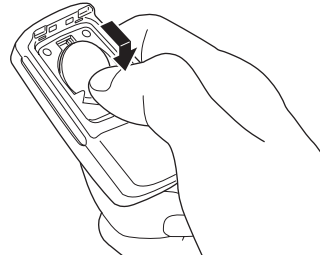

3. Insert a new battery with the + face up.
4. Fit the two prongs on the battery cover into the two notches and close the battery cover. A click is heard when the cover is in place.

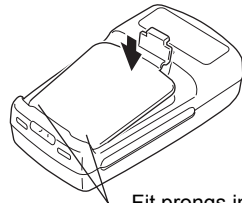

Fit prongs into notches

**20.2** **SDL1X Standard**

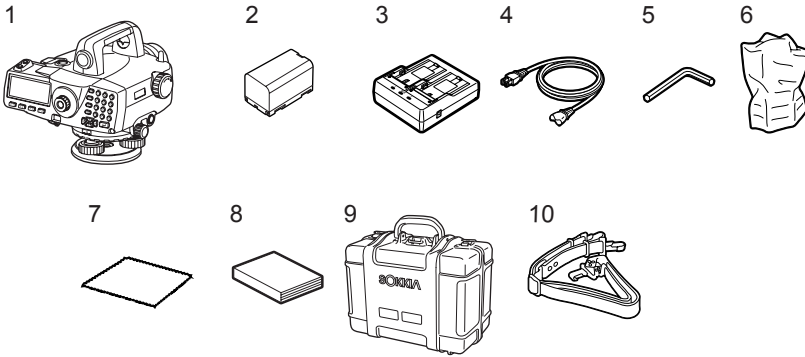

|    |   |   |
|----|---|---|
| 1  | SDL main unit . . . . .   | 1 |
| 2  | Battery (BDC58) . . . . .   | 1 |
| 3  | Battery charger (CDC68) . . . . .   | 1 |
| 4  | Power cable (EDC113A/113B/113C) . . . . .   | 1 |
| 5  | Hexagonal wrench (M2.5) (for both circular level and reticle adjustments) . . . . . | 1 |
| 6  | Vinyl cover . . . . .   | 1 |
| 7  | Cleaning cloth . . . . .  | 1 |
| 8  | Operator's manual. . . . .  | 1 |
| 9  | Carrying case (SC230) . . . . .   | 1 |
| 10 | Carrying strap (SC96B) . . . . .  | 1 |

**Note**

•Optional accessory DE28/29 can also be placed in the carrying case.

# 21.OPTIONAL ACCESSORIES

The following are optional accessories which are sold separately from the SDL.

- **Remote Trigger (DLC1)**

Optional accessory for the SDL1X Standard.

- **Diagonal eyepiece (DE28/DE29)**

The diagonal eyepiece is convenient for observations in narrow spaces.

Magnification:

DE28: 32X

DE29: 44X

First remove the standard SDL eyepiece by turning it counter-clockwise. Then screw the diagonal eyepiece into place.

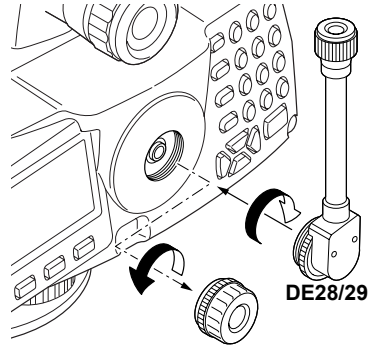

- **Interface cable**

Connect the SDL to a data collector using the following cable.

| Cable  | Notes  |
|--------|--|
| DOC129 | Pin number and signal level : RS232C compatible<br>D-Sub connector : 9 pins (female) |

- **Staves**

| Name   | Material        | Length/Front/Reverse  | Feature   |
|--------|-----------------|---|---|
| BIS30A | New Super Invar | 3.038m (9.8ft)<br>Front: RAB code*                            | ISO 12858-1: 1999 compatible<br>For high precision leveling |
| BIS30  | Invar           | 3.038m (9.8ft)<br>Front: RAB code*                            | ISO 12858-1: 1999 compatible                                |
| BIS20  | Invar           | 2.0m (6.6ft)<br>Front: RAB code*                              | ISO 12858-1: 1999 compatible                                |
| BGS40  | Glass fiber     | 4.08m (3 sections)<br>Front : RAB code*<br>Reverse: graduated | With handle   |
| BGS50  | Glass fiber     | 5.09m (4 sections)<br>Front : RAB code*<br>Reverse: graduated | With handle   |

\*RAB code (RANdom Bi-directional code) is a coded staff used with SOKKIA digital levels.

# 22.SPECIFICATIONS

Except where stated, the following specifications apply to both SDL1X Advanced and SDL1X Standard.

## Telescope

|                           |                   |
|---------------------------|-------------------|
| Length:                   | 280mm             |
| Aperture:                 | 45mm (1.8 inch)   |
| Magnification             | 32X               |
| Image:                    | Erect             |
| Resolving power           | 3"                |
| Field of view             | 1°20' (2.3m/100m) |
| Minimum focus:            | 1.5m (5.0 ft)     |
| Stadia ratio:             | 1:100             |
| Stadia additive constant: | 0                 |

## View Finder (SDL1X Advanced only)

|                |                       |
|----------------|-----------------------|
| Length:        | 130mm                 |
| Aperture:      | 22mm (about 0.9 inch) |
| Magnification  | 4.5X                  |
| Image:         | Erect                 |
| Field of view  | 3°                    |
| Minimum focus: | 7m                    |

## Auto Focus (SDL1X Advanced only)

|                               |   |
|-------------------------------|---|
| Method:                       | Combination of passive/electronic distance measurement and contrast detection |
| Range:                        | 1.6m to 100m  |
| Minimum brightness level:     | 20lx at staff   |
| Auto Focus time:              | 0.8 to 4 sec. (outdoors, fine to cloudy conditions)                           |
| Auto Focus motion:            | Yes/No (selectable)   |
| Auto Focus/manual conversion: | No (Manual mode given priority by friction clutch)                            |

## Automatic compensator

|                        |   |
|------------------------|---|
| Automatic compensator: | Magnetic damping and pendulum mechanism |
| Compensation range:    | ±12'                                    |
| Setting accuracy:      | ±0.3"                                   |

## Tilt warning

|            |  |
|------------|--|
| Mechanism: | Liquid 2-axis tilt sensor                    |
| Range:     | ±8.5' (graphic level display and audio tone) |

## Measurement

|                    |  |
|--------------------|--|
| Horizontal circle: | Diameter: 103mm<br>Graduation: 1°/1 gon  |
| Measuring range*1: |  |
| Height             | 0.0375 to 1.9305m (0.124 to 6.333 ft) (with BIS20 staff)<br>0.0375 to 2.9725m (0.124 to 9.752 ft) (with BIS30/30A staff)<br>0 to 4m (13.123 ft) (with BGS40 staff)<br>0 to 5m (16.404 ft) (with BGS50 staff) |
| Distance           | Electronic measurement: 1.6 to 100m<br>Visual measurement: from 1.5m   |

Minimum display:  
 Height 0.00001/0.0001/0.001m (0.0001/0.001/0.01ft) (selectable)  
 Distance 0.001/0.01/0.1m (0.01/0.1/1ft) (selectable)

Accuracy\*1: (ISO17123-2 compatible)

Height (Standard deviation for 1 km of double-run leveling)  
 Electronic measurement 0.2mm (with BIS30A, SDL1X Advanced only)\*2  
 0.3mm (with BIS20/30)  
 1.0mm (with BGS40/50)  
 Visual measurement 1.0mm (with BGS40/50)

Distance (Electronic measurement)  
 ±10mm or less (10m or less)  
 ±(0.1% x D) or less (over 10 to less than 50m)  
 ±(0.2% x D) or less (50 to 100m)  
 (D: measured distance, unit: m)

Measuring modes: Single/Repeat/Average/Rapid (selectable)

Measuring time\*3  
 Single/Repeat less than 2.5 sec.  
 Average No. of measurements set × less than 2.5 sec.  
 Rapid repeat less than 1 sec.

Earth curvature and refraction correction:  
 No/Yes K=0.142/Yes K=0.20 (selectable)

- \*1 When measuring outdoors with minimal atmospheric motion, the staff set up in natural sunlight and luminosity at the surface of the staff equal to 20lx.
- \*2 When measuring with no atmospheric motion or scintillation, ambient temperature is stable and the instrument and staff are set up out of direct sunlight. Accuracy may be affected by wind conditions and the set up of the instrument and staff.
- \*3 When measuring to a staff set up outdoors in fine to cloudy conditions.
- \*1, 3 These specifications may change depending on the weather conditions and measurement conditions.

**Internal memory**

Capacity 10,000 measurement points

**External memory**

SD card (up to 2 GB)  
 USB flash memory (up to 4 GB)

**Data transfer**

Data input/output Asynchronous serial, RS232C compatible  
 USB USB Ver. 1.1, Host (Type A)  
 Card slot SD card

**Bluetooth wireless communication**

BT Qualification ID B011340, B012647  
 Transmission method: FHSS (Bluetooth Specification Ver.2.0+EDR compatible, Telec-approved)  
 Modulation: GFSK, π/4DQPSK, 8DPSK  
 Frequency band: 2.402 to 2.48GHz  
 Bluetooth profile SPP  
 Power class Class 1

## 22. SPECIFICATIONS

---

|                |  |
|----------------|--|
| Usable range   | to 100m (usable range may vary with different paired devices)<br>(No obstacles, few vehicles or sources of radio emissions/<br>interference in the near vicinity of the instrument, no rain) |
| Authentication | Yes/No (selectable)  |

### Power Supply

|   |  |
|---|--|
| Power source:                           | Rechargeable Li-ion battery BDC58      |
| Working duration at 20 °C (using BDC58) |  |
| SDL1X Advanced                          |  |
| Manual focus and measurement:           | about 12 hours                         |
| Automatic focus and measurement:        |  |
| SDL1X Standard                          | about 9 hours                          |
| SDL1X Standard                          | about 14 hours                         |
| Battery state indicator                 | 4 levels                               |
| Auto power-off:                         | 2 levels (30 min/Not set) (selectable) |

### Battery (BDC58)

|                 |                             |
|-----------------|-----------------------------|
| Nominal voltage | 7.2V                        |
| Capacity        | 4.3 Ah                      |
| Dimensions      | 38 (W) x 70 (D) x 40 (H) mm |
| Weight          | about 195g                  |

### Battery (BDC46B)

|                 |                             |
|-----------------|-----------------------------|
| Nominal voltage | 7.2V                        |
| Capacity        | 2.45Ah                      |
| Dimensions      | 38 (W) x 70 (D) x 20 (H) mm |
| Weight          | about 103g                  |

### Charger (CDC68)

|                                      |   |
|--------------------------------------|---|
| Input voltage:                       | AC100 to 240V   |
| Charging time per battery (at 25°C): | about 4 hours<br>(Charging can take longer than the times stated above when<br>temperatures are either especially high or low.) |
| Charging temperature range:          | 0 to 40°C   |
| Storage temperature range:           | -20 to 65°C   |
| Size:                                | 94 (W) X 102 (D) X 36 (H) mm  |
| Weight:                              | about 170g  |

### General

|                             |  |
|-----------------------------|--|
| Display:                    | LCD graphic display, 192 dots X 80 dots              |
| Backlight                   | LED: ON/OFF (selectable)                             |
| Operation panel (Keyboard)  | 27 keys (soft function, operations, power on, light) |
| Key backlight               | Yes  |
| Measure key                 | Yes (right side)                                     |
| Calendar/clock function:    | Yes  |
| Circular level sensitivity: | 8/2 mm   |
| Operating temperature       | -20 to 50°C (no condensation)                        |
| Storage temperature range   | -40 to 70°C (no condensation)                        |
| Dust and water resistance   | IP54 (IEC 60529:2001)                                |



Instrument size (with handle): 226 (W) X 260 (D) X 200 (H) mm

Instrument weight:

SDL1X Advanced 3.5 kg (7.7 lb) (with BDC58)

SDL1X Standard 3.4 kg (7.5 lb) (with BDC58)

### Staffs

New Super Invar (ISO 12858-1:1999 compatible)

BIS30A

Coefficient of linear expansion:  $0 \pm 0.1 \times 10^{-6} / ^\circ\text{C}$

Scale range: 37.5 to 2972.5mm

Size: 85 (W) X 40 (D) X 3038 (H) mm

Weight: 5.5kg (staff only), 23.4kg (case containing 2 staffs)

Invar (ISO 12858-1:1999 compatible)

BIS30

Coefficient of linear expansion:  $1 \times 10^{-6} / ^\circ\text{C}$

Scale range: 37.5 to 2972.5mm

Size: 85 (W) X 40 (D) X 3038 (H) mm

Weight: 5.5kg (staff only), 23.4kg (case containing 2 staffs)

BIS20

Coefficient of linear expansion:  $1 \times 10^{-6} / ^\circ\text{C}$

Scale range: 37.5 to 1930.5mm

Size: 85 (W) X 40 (D) X 2000 (H) mm

Weight: 4.3kg (staff only), 17.1kg (case containing 2 staffs)

Glass fiber

BGS40

Coefficient of linear expansion:  $20 \times 10^{-6} / ^\circ\text{C}$

Scale range: 0 to 4080mm

Size: 58 (W) X 28 (D) X 4080 (H) mm

Weight: 2.4kg (1 staff only), 3.0kg (w/ case)

BGS50

Coefficient of linear expansion:  $20 \times 10^{-6} / ^\circ\text{C}$

Scale range: 0 to 5090mm

Size: 58 (W) X 28 (D) X 5090 (H) mm

Weight: 3.0kg (1 staff only), 3.6kg (w/ case)

### Remote trigger (DLC1) (optional accessory for the SDL1X Standard)

Interface: Modulated infrared LED

Power source: Coin-type battery x 1 (CR2032) (3V DC)

Operating range: within 0.5m (operating range may vary with different operating conditions)

Number of keys: 3

Dust and water resistance: IP66 (IEC60529:2001)

Size: 40(W) x 68(D) x 22(H) mm

Weight: Approx. 35g (with battery cell)

# 23.REGULATIONS

Users must ensure that their instrument is compliant with the relevant regulations and legal restrictions in place in the country of use.

## For users in the US

---

**WARNING:** Changes or modifications to this unit not expressly approved by the party responsible for compliance could void the user's authority to operate the equipment.

**NOTE:** This equipment has been tested and found to comply with the limits for a Class A digital device pursuant to Part 15 of the FCC Rules. These limits are designed to provide reasonable protection against harmful interference when the equipment is operated in a commercial environment. This equipment generates, uses, and can radiate radio frequency energy and, if not installed and used in accordance with the instruction manual, may cause harmful interference to radio communications. Operation of this equipment in a residential area is likely to cause harmful interference in which case the user will be required to correct the interference at his own expense.

This transmitter must not be co-located or operated in conjunction with any other antenna or transmitter.

This equipment complies with FCC radiation exposure limits set forth for uncontrolled equipment and meets the FCC radio frequency (RF) Exposure Guidelines in Supplement C to OET65. This equipment should be installed and operated with at least 20cm and more between the radiator and person's body (excluding extremities: hands, wrists, feet and ankles).

## For users in California

**WARNING:** Handling the cord on this product or cords associated with accessories sold with this product will expose you to lead, a chemical known to the State of California to cause birth defects or other reproductive harm. ***Wash hands after handling.***

This product contains a CR Lithium Battery which contains Perchlorate Material - special handling may apply.

See <http://www.dtsc.ca.gov/hazardouswaste/perchlorate/>

Note: This is applicable to California, U.S.A only.

**For users in Canada**

---

This Class A digital apparatus meets all requirements of Canadian Interference-Causing Equipment Regulations.

Cet appareil numérique de la Class A respecte toutes les exigences du Règlement sur le matériel brouilleur du Canada.

This class A digital apparatus complies with Canadian ICES-003.

Cet appareil numérique de la classe A est conforme à la norme NMB-003 du Canada.

Operation is subject to the following two conditions: (1) this device may not cause interference, and (2) this device must accept any interference, including interference that may cause undesired operation of this device.

This equipment complies with IC radiation exposure limits set forth for uncontrolled equipment and meets RSS-102 of the IC radio frequency (RF) Exposure rules. This equipment should be installed and operated with at least 20cm and more between the radiator and person's body (excluding extremities: hands, wrists, feet and ankles).

**SOKKIA**

E0089

## CE Conformity Declaration

in accordance with EMC Directive 2004/108/EC and R&TTE Directive 1999/5/EC  
of the European Community

We herewith declare that the undermentioned instrument, in view of its design and type of construction, fully complies with the relevant basic radio interference requirements of the EMC and R&TTE Directive.

Should the instrument be modified without agreement, this declaration becomes invalid.

Instrument Description : WT11 Bluetooth Module

Model Name : WT11

Relevant EC Directive : EMC Directive(2004/108/EC)  
R&TTE Directive(99/5/EC)

## Applied

|                       |        |                       |
|-----------------------|--------|-----------------------|
| Harmonized Standard : | Radio  | EN 300 328 2006-10    |
|                       | EMC    | EN 301 489-1 2005-09  |
|                       |        | EN 301 489-17 2002-08 |
|                       | Safety | EN 60950-1 :2001      |

Date: February 6, 2008

Firm: SOKKIA B.V.

Address: Industrieterrein De Vaart, Damsluisweg 1, NL-1332 EA Almere

Representative's Signature: \_\_\_\_\_

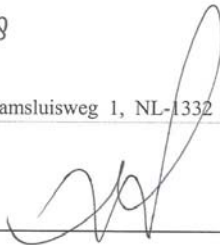

Name of Representative : Gerben Wolsink

Representative's position : European Service Manager

## SDL1X Digital Level with WT11

### Česky [Czech]

Sokkia BV potvrzuje, že výše uvedené zařízení je v souladu se základními požadavky a dalšími příslušnými ustanoveními směrnice 1999/5/ES.

### Dansk [Danish]

Undertegnede, Sokkia B.V. erklærer herved, at følgende udstyr det ovennævnte udstyr overholder de væsentlige krav og øvrige relevante krav i direktiv 1999/5/EF.

### Deutsch [German]

Sokkia B.V. erklärt, dass die oben genannten Instrumente in Übereinstimmung mit den grundlegenden Anforderungen und den übrigen einschlägigen Bestimmungen der Richtlinie 1999/5/EG befindet.

### Eesti [Estonian]

Käesolevaga kinnitab Sokkia B.V., seadme ülal mainitud varustus direktiivi 1999/5/EÜ põhinõuetele ja nimetatud direktiivist tulenevatele teistele asjakohastele sätetele.

### English

Hereby, Sokkia B.V., declares that the above-mentioned equipment is in compliance with the essential requirements and other relevant provisions of Directive 1999/5/EC.

### Español [Spanish]

Por medio de la presente Sokkia B.V., declara que el equipo arriba mencionado cumple con los requisitos esenciales y cualesquiera otras disposiciones aplicables o exigibles de la Directiva 1999/5/CE.

### Ελληνική [Greek]

ΜΕ ΤΗΝ ΠΑΡΟΥΣΑ Sokkia B.V., ΔΗΛΩΝΕΙ ΟΤΙ ο προαναφερόμενος εξοπλισμός ΣΥΜΜΟΡΦΩΝΕΤΑΙ ΠΡΟΣ ΤΙΣ ΟΥΣΙΩΔΕΙΣ ΑΠΑΙΤΗΣΕΙΣ ΚΑΙ ΤΙΣ ΛΟΙΠΕΣ ΣΧΕΤΙΚΕΣ ΔΙΑΤΑΞΕΙΣ ΤΗΣ ΟΔΗΓΙΑΣ 1999/5/ΕΚ.

### Français [French]

Par la présente Sokkia B.V., déclare que l'équipement mentionné ci-dessus est conforme aux exigences essentielles et aux autres dispositions pertinentes de la directive 1999/5/CE.

### Italiano [Italian]

Con la presente Sokkia B.V., dichiara che questo II sopra menzionato equipaggiamento è conforme ai requisiti essenziali ed alle altre disposizioni pertinenti stabilite dalla direttiva 1999/5/CE.

### Latviski [Latvian]

Ar šo Sokkia B.V., deklarē, ka augstāk minētā iekārta atbilst Direktīvas 1999/5/EK būtiskajām prasībām un citiem ar to saistītajiem noteikumiem.

### Lietuvių [Lithuanian]

Šiuo Sokkia B.V., deklaruoja, kad šis aukščiau mineta iranga atitinka esminius reikalavimus ir kitas 1999/5/EB Direktyvos nuostatas.

### Magyar [Hungarian]

Alulírott, Sokkia B.V. nyilatkozom, hogy a fent említett eszköz megfelel a vonatkozó alapvető követelményeknek és az 1999/5/EC irányelv egyéb előírásainak.

### Malti [Maltese]

Hawnhekk, Sokkia B.V., tidjickjara li t-tagħmir insemmi hawn fuq hu konformi mal-htigijiet essenzjali u provvedimenti rilevanti oħrajn ta' Direttiva 1999/5/KE.

### Nederlands [Dutch]

Hierbij verklaart Sokkia B.V., dat bovengenoemd toestel in overeenstemming is met de essentiële eisen en de andere relevante bepalingen van richtlijn 1999/5/EG.

### Polski [Polish]

Niniejszym Sokkia B.V. oświadczam, że sprzęt wymieniony powyżej jest zgodny z zasadniczymi wymogami oraz pozostałymi stosownymi postanowieniami Dyrektywy 1999/5/EC.

### Português [Portuguese]

Sokkia B.V. declara que este o equipamento acima mencionado está conforme com os requisitos essenciais e outras disposições da Directiva 1999/5/CE.

## 23. REGULATIONS

---

### Slovensko [Slovenian]

Sokkia B.V. izjavlja, da je ta zgoraj omenjena oprema v skladu z bistvenimi zahtevami in ostalimi relevantnimi določili direktive 1999/5/ES.

### Slovensky [Slovak]

Sokkia BV potvrdzuje, že vyššie uvedené zariadenie je v súlade so základnými požiadavkami a všetky príslušné ustanovenia Smernice 1999/5/ES.

### Suomi [Finnish]

Sokkia B.V. vakuuttaa täten että ylläoleva laite tyyppinen laite on direktiivin 1999/5/EY oleellisten vaatimusten ja sitä koskevien direktiivin muiden ehtojen mukainen.

### Svenska [Swedish]

Härmed intygar Sokkia B.V. att den ovan nämnda utrustningen står i överensstämmelse med de väsentliga egenskapskrav och övriga relevanta bestämmelser som framgår av direktiv 1999/5/EG.

### Íslenska [Icelandic]

Hér með staðfestir Sokkia B.V. að áður nefndur búnaður er í samræmi við grundvallarskilyrði og aðrar viðeigandi kröfur í fyrimæli Evrópusambandsins 1999/5/EC.

### Norsk [Norwegian]

Sokkia B.V. erklærer herved at utstyret nevnt ovenfor oppfyller de ubetingede krav og andre relevante bestemmelser i Direktiv 1999/5/EC.

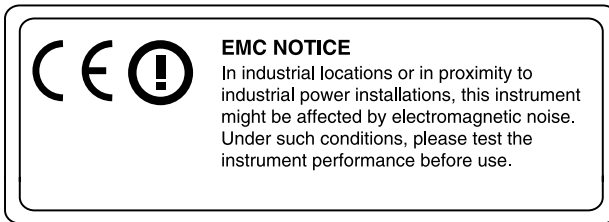

## **For users in Mexico**

---

Este equipo opera a título secundario, consecuentemente, debe aceptar interferencias perjudiciales incluyendo equipos de la misma clase y puede no causar interferencias a sistemas operando a título primario.

COFETEL + RCPSOWT08-0101

---

**For users in Taiwan**

---

低功率電波輻射性電機管理辦法 (930322)

第十二條 經型式認證合格之低功率射頻電機，非經許可，公司、商號或使用者均不得擅自變更頻率、加大功率或變更原設計之特性及功能。

第十四條 低功率射頻電機之使用不得影響飛航安全及干擾合法通信；經發現有干擾現象時，應立即停用，並改善至無干擾時方得繼續使用。

前項合法通信，指依電信法規定作業之無線電通信。

低功率射頻電機須忍受合法通信或工業、科學及醫療用電波輻射性電機設備之干擾。

---

**For users in the United Arab Emirates**

---

Approved by TRA







**SOKKIA TOPCON CO., LTD.**

<http://www.sokkia.co.jp/english/>

260-63 HASE, ATSUGI, KANAGAWA, 243-0036 JAPAN

3rd ed. 03-0911

©2009 SOKKIA TOPCON CO., LTD.